

RESTRICTED

TM 11-281

WAR DEPARTMENT

TECHNICAL MANUAL

**RADIO SETS SCR-399-A
& SCR-499-A**

4 September 1943

WAR DEPARTMENT

Washington 25, D.C., 1 June 1944

This Technical Manual published on Order 26804-PHILA-44-07 is furnished for the information and guidance of all concerned.

RESTRICTED

This document contains information affecting the national defense of the United States within the meaning of the Espionage Act, 50 U. S. C., 31 and 32 as amended. Its transmission or the revelation of its contents in any manner to an unauthorized person is prohibited by law.

The information contained in restricted documents and the essential characteristics of restricted materiel will not be communicated to the public or to the press, but may be given to any person known to be in the service of the United States and to persons of undoubted loyalty and discretion who are cooperating in Government work. (AR 380-5)

RESTRICTED

SUPPLEMENT
20 July 1944
TM 11-281

SUPPLEMENT
to
TECHNICAL MANUAL
TM 11-281
RADIO SETS SCR-399-A
& SCR-499-A

4 September 1943

The following information, published on Order No. 26804-PHILA-44-07, supplements TM 11-281, 4 September 1943. Personnel using the equipment and having custody of this technical manual will attach this supplement securely inside the front cover of the TM and will enter suitable notations beside each changed paragraph in the TM to indicate the presence of this supplementary information.

RESTRICTED

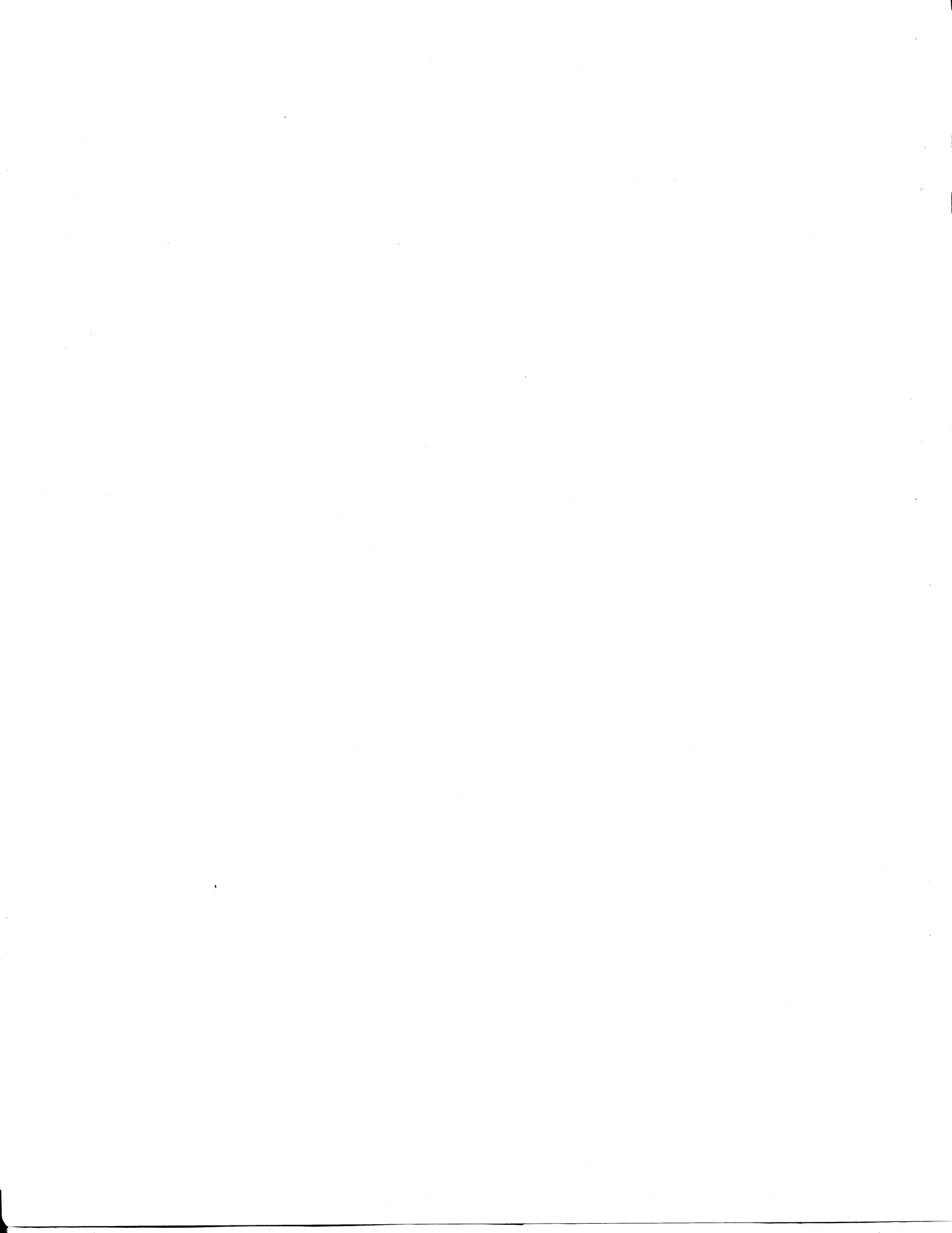

SUPPLEMENT

to

TECHNICAL MANUAL

RADIO SETS SCR-399-A & SCR-499-A

4 September 1943

The following information, published on Order No. 26804-Phila-44-07, supplements TM 11-281, 4 September 1943. Personnel using the equipment and having custody of this technical manual will attach this supplement securely inside the front cover of the TM and will enter suitable notations beside each changed paragraph in the TM to indicate the presence of this supplementary information.

Page 1: Table of contents. SECTION V. SUPPLEMENTARY DATA. Delete Table of Replaceable Parts, paragraph 35, and substitute the following:

- Maintenance Parts List for Radio Transmitter BC-610-E35
- Maintenance Parts List for Tuning Units TU-47 through TU-54.....35.1
- Maintenance Parts List for Speech Amplifier BC-614-E.....35.2

Page 24: Present JB-70-A equipments are marked Fig. 11 "ON" and "OFF" in place of "AUTO" and "MAN.", respectively, as shown.

Page 27: In the third line "Chest CH-120-A" Par. 11. should read "Chest CH-121-A".
d. (1)

Par. 11 CAUTION NOTE: On metal clad shelter HO-17, use only modified Mounting Ring, G 28656 (having 3¹³/₁₆" I.D.) with MP-47-A to prevent flashover.

Page 42: Second line in the text "V₉ is always Par. 18. tuned to twice the frequency of the master oscillator circuit" should read "V₉ is always tuned to twice the frequency of the master oscillator circuit except when Tuning Unit TU-54 is used, in which case the plate circuit of tube V₉ is tuned to four times the frequency of the master oscillator circuit."

Page 46: In the sixth line "R₁₄₂" should read Par. 20. "R₁₂₃."
b. (2)(b)

Page 49: Insert the following note directly under Sec. IV the heading SECTION IV—MAINTENANCE:

Note: Failure or unsatisfactory performance of equipment will be reported on W.D., A.G.O. Form No. 468. If this form is not available, see TM 38-250.

Page 58: Delete Table of Replaceable Parts, Par. 35 graph 35, and substitute Maintenance Parts List, page 3 of this supplement.

Page 71: See revised Fig. 17A in this supplement. Fig. 17 The revised schematic (Fig. 17A) shows:

- a. SW₁₀ deleted from circuit. Effective on BC-610-E Serial No. 6, Order No. 26804-Phila-44-07.
- b. SW₂ and SW₁₃ wired in the primary circuit of transformer T₆. Effective on BC-610-E Serial No. 6 on Order No. 26804-Phila-44-07.
- c. T₂ transformer secondary not center tapped.
- d. V₁₀₆ plate circuit revised. On some equipments to increase the available sidetone level, the plate lead of tube V₁₀₆ is connected to R₁₂₅ (the high voltage side of R₁₂₆) as shown in Fig. 17A. This also affects Fig. 20, Page 74. This change was effective on Speech Amplifier BC-614-E, Serial No. 1151 Order No. 30203-Phila-43-07.

Page 72: Schematic wiring diagram of Tuning Fig. 18 Unit TU-54.

In some equipments coil L_{36} is untapped, singly wound, in which case the wire from terminal No. 8 of PL_{10} is connected to the top end of coil L_{36} (the stationary plate of C_{32}).

Page 73: On some equipments RY_1 , G 29053, is superseded by RY_1 , G 29056. Revised wiring for Plate Power Relay RY_1 , G 29056; as used on Order No. 30203-Phila-43-07 is shown here.

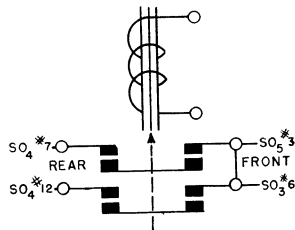

See Fig. 19A in this supplement for revised wiring of RY_1 for Order No. 26804-Phila-44-07, which shows:

- a. SW_{10} deleted from circuit.
- b. SW_2 and SW_{13} wired in primary circuit of transformer T_6 .
- c. T_2 transformer secondary not center tapped.
- d. The practical wiring of new type relay RY_1 , G 29056. This was effective on BC-610-E Serial No. 6, Order No. 26804-Phila-44-07.
- e. NOTE: The following cables were altered to provide for the new wiring of interlock switches SW_2 and SW_{13} :

1. Modulator Cable Assy.
2. Exciter Cable Assy.
3. Modulator to Exciter Cable Assy.
4. Top Cover Cable Assy.

NOTE: Old type interlock switches for SW_2 , SW_{10} , and SW_{13} are not interchangeable with new type part No. B 29320, because of insufficient current carrying capacity of both old type switches and cables.

Page 74: See Fig. 17A for revised V_{106} plate circuit wiring. NOTE: On some equipment T_{104} has terminals No. 6 and 7 reversed.

Page 78: See revised Fig. 17A and Fig. 19A for Fig. 23 T_2 non-center tapped secondary.

Page 79: See revised Fig. 17A and Fig. 19A for Fig. 24 T_2 non-center tapped secondary.

Page 80: See revised Functional Diagram Fig. Fig. 25 25A in this supplement.

The revised diagram shows:

- a. RY_3 corrected to RY_1 .
- b. Two additional leads from SW_{203} transmitter control switch to RY_{200} relay were added to correct diagram.
- c. Resistor R_{102} corrected to R_{101} .

Page 58: The following paragraphs are substituted for paragraph 35 for purposes of requisition. Only maintenance parts appearing in this list can be requisitioned.

35. Maintenance Parts List for Radio Transmitter BC-610-E.

NOTE: Order maintenance parts by stock number, name, and description.
Only maintenance parts listed can be requisitioned.

Ref Symbol	Signal Corps Stock No.	Name of part and description	Quantity per unit	Running spares	Orgn stock	3d ech	4th ech	5th ech	Depot stock
C ₂₈	2Z1231-1 2Z1247.1 3D423	BRACKET; resistor; Ohmite No. 9 BRACKET; resistor; Ohmite No. 18 CAPACITOR CA-423; fixed; Vacuum; 50-mmf; 32,000-v ac; Eitel McCullough type VC-50	6 4 1				*	*	*
C ₁₃	3D9150-19	CAPACITOR; fixed; mica; 150-mmf = 20%; 500-v dc; Aerovox 1460	1				*	*	*
C ₁₄	3D9200-35	CAPACITOR; fixed; mica; 200-mmf = 10%; 500-v dc; Aerovox 1460	1				*	*	*
C ₈	3D9250-12	CAPACITOR; fixed; mica; 250-mmf = 20% 1,000-v dc (test); Aerovox 1468	1	1			*	*	*
C ₂₉	3K4510211	CAPACITOR; fixed; mica; 1,000-mmf = 10%; 2,500-v dc (working); Aerovox 1447	1				*	*	*
C ₁₁	3DA2-84	CAPACITOR; fixed; mica; 2,000-mmf = 10%; 500-v dc; Aerovox 1460	1				*	*	*
C ₁₅	3DA2-85	CAPACITOR; fixed; mica; 2,000-mmf = 5%; 6,000-v dc	1				*	*	*
C ₁₅	3DA2-86	CAPACITOR; fixed; mica; 2,000-mmf = 10%; 6,000-v dc; Aerovox 1450	1				*	*	*
C ₁₇ -C ₁₉ -C ₂₁ -C ₂₆	3DA6-2	CAPACITOR; fixed; paper; 6,000-mmf = 20%; 600-v dc (molded); Mica-mold 340	7				*	*	*
C ₁₉ -C ₂₃	3DB3.8	CAPACITOR; fixed; oil-filled; 3-mf -10% +40%; 4,000-v dc; Industrial Cond. No. 7459	2				*	*	*
C ₁₂	3D9150V-4	CAPACITOR; variable; air; 150-mmf max; 7,000-v dc E. F. Johnson; 150DD70	1				*	*	*
C ₁₈	3D9005VE5 3D9075-6	CAPACITOR; variable; air; 5.5-mmf max; 3,000-v dc; E. F. Johnson 6G70 CAPACITOR; fixed; mica; 75-mmf = 20%; 500-v dc; CD type SW	1 1				*	*	*
C ₃₀ -C ₂₁	3DB8-34	CAPACITOR; fixed; electrolytic; 8-mf -10% +40%; 600-v dc; Industrial Cond. 60B5	2				*	*	*
C ₂₇	3DB40-5	CAPACITOR; fixed; electrolytic; 40-mf -10% +40%; 100-v dc; Industrial Cond. 10B231	1				*	*	*
C ₉ -C ₁₀	3DA50-76	CAPACITOR; fixed; oil-filled; paper; dual; 50,000-mmf = 15%; 1,200-v dc (test); 600-v dc (working); Sprague P-6969	1				*	*	*
C ₆ -C ₇	3DA2-116	CAPACITOR; fixed; paper; 2,000-mmf = 20%; 600-v dc; Micamold No. 340	2				*	*	*
C ₂₄	3DA5-108	CAPACITOR; fixed; oil-filled; paper; 5,000-mmf = 20%; 1,000-v dc; Aerovox, Hallicrafters No. 46A007, Detrola No. G 26051	1				*	*	*
CH ₃	3C375-1	COIL; choke; r-f; 2.2-mh = 5%; 25-ohm dc; Guthman, Hallicrafters No. 53A033, Detrola No. G 26303	1				*	*	*
CH ₁ -CH ₇	3C363	CHOKES: r-f; 1.0-mh = 10%; 20-ohm dc; Guthman No. 4885	6				*	*	*
CH ₅ -CH ₈	3C308-3	CHOKES: r-f; 2.5-mh = 10%; 8.5-ohm dc; 500-ma; SW Inductor No. CH 500	1				*	*	*
CH ₄	3C550	CHOKES: r-f; 10-mh = 10%; 42-ohm dc; Guthman No. 4979	1				*	*	*
CH ₉	2Z2626.11	CLAMP; tube base and capacitor; Hallicrafters No. 76A029, Detrola No. G 26899, Industrial Cond. No. 11-86	3				*	*	*
	2Z2712	CLIP; grid; National No. 12	2				*	*	*
	2Z2724	CLIP; grid; National No. 24	1				*	*	*

*Indicates stock available.

35. Maintenance Parts List for Radio Transmitter BC-610-E (contd).

NOTE: Order maintenance parts by stock number, name, and description.
Only maintenance parts listed can be requisitioned.

Ref Symbol	Signal Corps Stock No.	Name of part and description	Quantity per unit	Running spares	Orgn stock	3d ech	4th ech	5th ech	Depot stock
L ₇	3C280-387-A	COIL C-387-A: r-f; final amplifier plate; 2.0-3.4-mc; Barker & Williamson No. 51C538	2				*	*	*
L ₇	3C280-388A	COIL C-388-A: r-f; final amplifier plate; 3.4-4.4-mc; Barker & Williamson No. 51C539	2				*	*	*
L ₇	3C280-389A	COIL C-389-A: r-f; final amplifier plate; 4.4-5.7-mc; Barker & Williamson No. 51C540	2				*	*	*
L ₇	3C280-390A	COIL C-390-A: r-f; final amplifier plate; 5.7-8.0-mc; Barker & Williamson No. 51C541	2				*	*	*
L ₇	3C280-447	COIL C-447-A: r-f; final amplifier plate; 8.0-11.0-mc; Barker & Williamson No. 51C542	2				*	*	*
L ₇	3C280-448A	COIL C-448-A: r-f; final amplifier plate; 11.0-14.0-mc; Barker & Williamson No. 51C543	2				*	*	*
L ₇	3C280-449	COIL C-499-A: r-f; final amplifier plate; 14.0-18.0-mc; Barker & Williamson No. 51C544	2				*	*	*
	2Z3291-1	COUPLING: ceramic; flexible; Johnson No. 251	1				*	*	*
	2Z3270-8	COUPLING; flexible; 1/4" x 1/4"; Hallicrafters No. 72A005, Detrola No. G 26702	1				*	*	*
	2Z3402-7	COVER; overload relay; Hallicrafters No. 70A711, Detrola No. G 26660	1				*	*	*
	2Z6195.7	DIAL LOCK ASSEMBLY: Crowe No. P60875	1				*	*	*
	2Z3708-5	DIAL: locking; Crowe No. P59917	1				*	*	*
	2Z3719-7	DIAL DRIVE MECHANISM: Oak Mfg. Co. type No. 6301-2	1				*	*	*
	2Z3108-4	DIAL: scale 0-100; Crowe No. P59482	1				*	*	*
FS ₁ -FS ₂	3Z2025	FUSE: plug; 25-amp; 125-v; Effengee 4325	2	6			*	*	*
FS ₃	3Z2020	FUSE: plug; 20-amp; 125-v; Effengee 4320	1	6			*	*	*
	3Z2605.2	FUSE: 5-amp; 250-v; Littelfuse 1358	1	6			*	*	*
FS ₄	3Z1935	FUSE: type 4AG; 5-amp; 125-v; Littelfuse 1094	1	6			*	*	*
FS ₅	3Z1950	FUSE: type 3AG; 3-amp; 250-v; Littelfuse 1043	1	6			*	*	*
	6C46C/G1	GROMMET: 3/8"; rubber; black; 1/4" thick; Atlantic India Rubber No. 763, Hallicrafters No. 16A002, Detrola No. G 25551	1				*	*	*
	6Z4856-9	GROMMET: 1/2"; rubber; black; 1/4" thick; Atlantic India Rubber No. 1724, Hallicrafters No. 16A008, Detrola No. G 25553	6				*	*	*
	3G1250-16	INSULATOR POST: 1"; cylindrical; ceramic; Centralab, Hallicrafters No. 8A003, Detrola No. G 25251	3				*	*	*
	3G1837-32.8	INSULATOR: cylindrical; bakelite; Hallicrafters No. 8A023, Detrola No. G 25256	1				*	*	*
	3G1000-8.4	INSULATOR: cone; ceramic; Johnson No. 501	4				*	*	*
	3G1250-6.4	INSULATOR: button; ceramic; (feed-thru); American Lava No. 1440	2				*	*	*
	3G1050-36	INSULATOR ASSEMBLY: (feed thru); No. 1165; Hallicrafters No. 8A069, Detrola No. G 25284	2				*	*	*

3G1250-6.5	INSULATED SPACER: ceramic; (part of tank coil); Hallicrafters No. 8A051-0, Detrola No. G 25286.	14	*	*	*
2Z75594.11	JACK BAR ASSEMBLY: Barker & Williamson A54, Hallicrafters No. 8B006, Detrola No. G 27651.	1	*	*	*
2Z75927	LAMP LM-27: 6-8-v; 0.25-amp; bayonet base; type 44.	2	*	*	*
2Z75903	LAMP: 120-v; 6-watt; candelabra; type S6; clear.	2	*	*	*
2Z75988	LAMP: pilot; red; Dial Light Co. of America.	1	*	*	*
2Z75988-6	LAMP: pilot; green; Dial Light Co. of America.	1	*	*	*
3F901E5-14	MILLIAMETER: multiple; scale; (no substitute); General Electric DO-54.	1	*	*	*
3F950-20	MILLIAMETER: 0-500-ma dc; bakelite case; (substitute War Standard Meter No. MR25W500DCMA); GE DO-53.	1	*	*	*
3F930-10	MILLIAMETER: 0-300-ma dc; bakelite case; (substitute War Standard Meter No. MR25W300DCMA); GE DO-53.	1	*	*	*
2Z7228-14.1	PLUG: 6-contact; male; Jones P-406-Lab.	3	*	*	*
2Z7228-1	PLUG: 8-contact; male; square; Jones P408-Lab, Hallicrafters No. 10A060, Detrola No. G 25319.	2	*	*	*
3G1100-68-1	POST: ceramic; for 150 DD70 variable air capacitor; Johnson Type D, Hallicrafters No. 8A037, Detrola No. G 25292.	1	*	*	*
2Z7261	POTENTIOMETER: 500-ohm \pm 5% 50-w; (bias voltage control); IRC PR50 or PR050.	1	*	*	*
3C560	REACTOR: 6-henry; 250-ma; 125-ohm dc; (exciter power supply filter); Standard Transformer 10C13.	3	*	*	*
3C560-1	REACTOR: 11-henry; 500-ma; 50-ohm dc; 5,000-v dc (test); (final amplifier supply filter); Standard Trans. Corp. 10C16.	1	*	*	*
2Z7717.5	RELAY: double-pole double-throw; 117-v ac; (overload protector); Guardian 32423.	1	*	*	*
2Z7717.4	RELAY: double-pole double-throw; 600-ma dc; (overload protector); Guardian 32422.	1	*	*	*
2Z7717.3	RELAY: double-pole double-throw; 117-v ac; (antenna short-out); Leach 1702MX.	1	*	*	*
2Z7717.2	RELAY: double-pole double-throw; 117-v ac; (phone c-w switching); Advance type 400.	1	*	*	*
2Z7717	RELAY: double-pole single-throw; 117-v ac; (plate power "on-off"); Leach No. 1154 (replaces GML type 251 (2Z7717)).	1	*	*	*
3Z6001F6-2	RESISTOR: 16-ohm; 600-watt; heater element; (primary voltage dropping); Eagle Electric EAE415A.	1	*	*	*
3Z6005-13	RESISTOR: 50-ohm \pm 5%; 1/2-watt; IRC BW 1/2.	2	*	*	*
3Z6050-52	RESISTOR: 500-ohm \pm 5%; 10-watt; Ohmite BD.	1	*	*	*
3Z6070-5	RESISTOR: 700-ohm \pm 5%; 20-watt; Utah EE.	1	*	*	*
3Z4607	RESISTOR: 750-ohm \pm 10%; 1-watt; No. RS-207; IRC BT1, RC31BE751J.	1	*	*	*
3Z6075-16	RESISTOR: 750-ohm \pm 5%; 10-watt; Ohmite BD.	1	*	*	*
3Z6250-27	RESISTOR: adjustable tap; 2,500-ohm \pm 5%; 100-watt; Ohmite D1VEU.	1	*	*	*
3Z6615-38	RESISTOR: 15,000-ohm \pm 5%; 20-watt; Utah 20 VWQ.	1	*	*	*

*Indicates stock available.

35. Maintenance Parts List for Radio Transmitter BC-610-E (contd).

NOTE: Order maintenance parts by stock number, name, and description.
Only maintenance parts listed can be requisitioned.

Ref Symbol	Signal Corps Stock No.	Name of part and description	Quantity per unit	Running spares	Orgn stock	3d ech	4th ech	5th ech	Depot stock
R ₇ -R ₁₇	3Z6620-12	RESISTOR: 20,000-ohm = 10%; 2-watt; IRC BT2, RC41BE203J.	4				*	*	*
R ₁	3Z4540	RESISTOR: 30,000-ohm = 10%; 1/2-watt; IRC BT 1/2, RC21BE303J.	1				*	*	*
R ₁₀	3Z6640-16	RESISTOR: 40,000-ohm = 5%; 20-watt; Utah EE.	1				*	*	*
R ₂₅	3Z6650-7	RESISTOR: 50,000-ohm = 10%; 2-watt; IRC BT2, RC41BE513J.	1				*	*	*
R ₁₃	3Z6675-15	RESISTOR: 75,000-ohm; 200-watt; Ohmite 0924.	1				*	*	*
R ₈	3RC41BE272	RESISTOR: 4,700-ohm = 10%; 2-watt; IRC BT2, RC41BE472K.	1				*	*	*
R ₅	3Z6018-12	RESISTOR: wire-wound; 180-ohm = 10%; 20-watt; IRC DG.	1				*	*	*
R ₂₉ -R ₃₃	3Z5987-4	RESISTOR: 0.741-ohm = 0.5%; temperature coefficient -0.015%; Hallcrafters dwg No. 24A825, Detrola No. G 25655.	2				*	*	*
R ₂₇	3Z5983-8	RESISTOR: 0.351-ohm = 0.5%; temperature coefficient -0.015%; Hallcrafters No. 24A826, Detrola No. G 25656.	1				*	*	*
R ₂₃	3RC31BE334M 2C4518/104	RESISTOR: 330,000-ohm = 20%; 1-watt; BT1, RC31BE334M.	1				*	*	*
R ₂	3Z6506-8	RESISTOR: 82,000-ohm = 10%; 1/2-watt; BT 1/2, RC21BE823K.	1				*	*	*
R ₁₁ -R ₁₅	3Z4550	RESISTOR: 5,600-ohm = 5%; 20-watt; Utah 20 VWQ.	1				*	*	*
R ₁₃	3Z7015-3	RESISTOR: 100,000-ohm = 10%; 1/2-watt; No. RS150.	2				*	*	*
SO ₃	2Z8659-6	RHEOSTAT: 15-ohm = 10%; approx 50-watt; IRC 15-ohm, PR 50 per Spec. Pr-709 Sub 2, or Ohmite G, Hallcrafters No. 25A501, Detrola No. G 25701.	1				*	*	*
SO ₁₁	2Z8678.43 2Z8768.43	SOCKET: octal; bakelite; (speech amplifier input); Amphenol MIP-8.	1				*	*	*
SO ₅	2Z8678.87	SOCKET: 8-contact; female; square; (receptacle); Jones No. S-408-AB.	1				*	*	*
SO ₆	2Z5883-21 6Z7588	SOCKET: 8-contact; female; modified Jones S-408-AB, per Hallcrafters No. 10A077, Detrola No. G 25313.	1				*	*	*
SO ₁ -SO ₂	2Z8678.87	SOCKET: Amphenol connector; Amphenol No. PO8F1, Hallcrafters No. 10BO40, Detrola No. G 27701.	1				*	*	*
SO ₄	2Z5883-21	SOCKET: pilot; light; with leads; Drake No. 204CE.	1				*	*	*
SO ₇ -SO ₈	6Z7588	SOCKET: male; twist-lock type; 20-amp; 250-v; Hubbell 8808.	1				*	*	*
SO ₉	2Z8639.1	SOCKET: 6-contact; female; Jones S-406-LAB.	3				*	*	*
SW ₁₁	2Z8639-5	SOCKET TERMINAL STRIP: 10-terminal; bakelite; Hallcrafters No. 81BO74, Detrola No. G 28703.	3				*	*	*
SW ₇	2C6500A/S1 3Z9845-14	SWITCH ASSEMBLY: 4-section; isolantite wafers; CRL 14BHC411D.	1				*	*	*
SW ₁ -SW ₄	3Z9851	SWITCH: toggle; 4-pole double-throw; bakelite; (phone c-w switching); Cutler Hammer 8885K1.	1				*	*	*
SW ₆	3Z9824-274	SWITCH: toggle; single-pole single-throw; bakelite; (filament "on-off"; exciter plate "on-off"; series resistor "on-off"); Effengee No. P & S-1311.	3				*	*	*
SW ₁₂	3Z9812-2 3Z9861-1	SWITCH: push-button; single-pole single-throw; bakelite; (over-load relay reset); Utah No. PS-3.	1				*	*	*
SW ₅	3Z9812-2	SWITCH: interlock; single-pole single-throw; bakelite; HH 3592D.	1				*	*	*
SW ₃	3Z9861-1	SWITCH: double-pole single-throw; bakelite; Effengee type P & S 1312.	1				*	*	*

SW ₈	3Z9825-62.5	SWITCH ASSEMBLY: 2-section; 4-position; Oak Mfg. per Hallicrafters No. 60A136, Detrola No. G 26401.	1	*	*	*
SW _{7-SW₁₁}	3Z9812-3	SWITCH: interlock; single-pole single-throw; HH 1796.	3	*	*	*
SW ₁₃	2Z9408.1	TERMINAL BLOCK: 8-terminal; (power supply chassis cable connection); Jones S-10-142.	1	*	*	*
TS ₃	2Z9412	TERMINAL STRIP: 12-terminal; Jones No. S-12-6.	2	*	*	*
TS ₄	2Z9402	TERMINAL STRIP: standard; 2-terminal; Cinch Mfg. Co. No. 1720.	1	*	*	*
TS ₅	2Z9402.1	TIP JACK STRIP: standard; 2-jack; Cinch Mfg. Co. 1490.	1	*	*	*
T ₁	2Z9613.3	TRANSFORMER: pri 117-v; sec 1,000-v ct at 220 ma; 2.5-v ct at 5 amps; 5-v ct at 3 amps; (bias supply plate power); Standard Transformer Co. No. 10P33.	1	*	*	*
T ₂	2Z9611.144	TRANSFORMER: pri 115-100-v ac; sec 2.5-v ct at 10 amps; (filament power); Standard Transformer Co. No. 10P50.	1	*	*	*
T ₃	2Z9614.1	TRANSFORMER: pri 115-100-v; sec 5-v ct at 10.5 amps; (filament power); Standard Transformer Co. No. 10P35.	1	*	*	*
T ₄	2Z9614.2	TRANSFORMER: pri 100-115-v; sec 5-v ct at 10.5 amps; 6.3-v ct at 3.5 amps; 5-v ct at 3 amps; (filament power); Standard Transformer Co. No. 10P36.	1	*	*	*
T ₅	2Z9612	TRANSFORMER: pri 125-115-v; sec 870-v ct at 250 ma; (exciter plate power); Standard Transformer Co. No. 10P37.	1	*	*	*
T ₆	2Z9612.1	TRANSFORMER: pri 115-v tapped to provide 5,000-v or 4,000-v ct at 500 ma; (plate power); Standard Transformer Co. No. 10P43.	1	*	*	*
T ₇	2Z9636	TRANSFORMER: pri 500-ohm; sec 20,000-ohm ct; (interstage); Standard Transformer Co. No. 10A021.	1	*	*	*
T ₈	2Z9632.2	TRANSFORMER: pri 5,000-ohm; ratio 1:1.35; 1/2 pri to 1/2 sec; (driver); Standard Transformer Co. No. 10A022.	1	*	*	*
T ₉	2Z9634.3	TRANSFORMER: pri 16,000-ohm ct; sec 8,330-ohm ct at 250 ma; (modulation); Standard Transformer Co. No. 10A38.	1	*	*	*
V ₆ -V ₇	2T46A	TUBE VT-46-A	2	*	*	*
V ₁ -V ₂	2T95	TUBE VT-95	2	*	*	*
V ₁₀ -V ₁₁	2T100	TUBE VT-100	2	*	*	*
V _k	2T107	TUBE VT-107	1	*	*	*
V ₅	2T115	TUBE VT-115	1	*	*	*
V ₁₃ -V ₁₄ -V ₁₄	2T139	TUBE VT-139	3	*	*	*
V ₇ -V ₁₂	2T145	TUBE VT-145	2	*	*	*
V ₃ -V ₄	2T218	TUBE VT-218	2	*	*	*
V ₁₆	2T220	TUBE VT-220	1	*	*	*
M ₃	3F8010-8	VOLTMETER: 0-10-v ac; bakelite case; General Electric type DO-53, substitute War Standard Meter No. MR25W010ACVY	1	*	*	*

*Indicates stock available.

35.1. Maintenance Parts List for Tuning Units TU-47 through TU-54.

NOTE: Order maintenance parts by stock number, name, and description.
Only maintenance parts listed can be requisitioned.

Ref Symbol	Signal Corps Stock No.	Name of part and description	Quantity per unit	Running spares	Orgn stock	3d ech	4th ech	5th ech	Depot stock
C ₄₄	2C8047	TUNING UNIT TU-47	3					*	*
C ₃₄	3D9240-2	CAPACITOR: fixed; mica; 250-mmf ±10%; 500-v dc; C-D No. 5W	1					*	*
C ₃₆	3D9150V-14	CAPACITOR: variable; air; 190-mmf max; Bud MC 1857	1					*	*
C ₄₇	3D9140-1	CAPACITOR: fixed; ceramic; 140-mmf ±5%; tc zero; 500-v dc; Hallcrafters No. 47A021, Detrola No. G 26102	1					*	*
L ₈	3DK9075-13	CAPACITOR: fixed; mica; 75-mmf ±10% 500-v dc; C-D type 5W	1					*	*
L ₁₄	3C1090	COIL: r-f; 96-mh; tapped; 2.0-2.5-mc; (master oscillator coil); Hallcrafters No. 51A468, Detrola No. G 26215, Guthman No. 4846	1					*	*
L ₂₆	3C1090-6	COIL: r-f; 28.8-mh; single winding; 2.0-2.5-mc; (crystal coil); Hallcrafters No. 51A450, Detrola No. G 26202, Guthman No. 4881	1					*	*
L ₂₇	3C1090-12	COIL: r-f; 36.3-mh; single winding; 2.0-2.5-mc; (doubler buffer coil); Hallcrafters No. 51A456, Guthman No. 4872, Detrola No. G 26208	2					*	*
C ₃₇	2C8048	TUNING UNIT TU-48	3					*	*
L ₉	3D9155-1	CAPACITOR: fixed; ceramic; 500-v dc; tc-0.00015 mmf/mm/degree centigrade; Muter	2					*	*
L ₂₇	3C1090-1	COIL: r-f; 55.5-mh; tapped; 2.5-3.2-mc; (master oscillator coil); Hallcrafters No. 51A467, Detrola No. G 26214, Guthman No. 4847	1					*	*
L ₁₅	3C1090-13	COIL: r-f; 30.8-mh; single winding; 2.5-3.2-mc; (doubler buffer coil); Hallcrafters No. 51A457, Detrola No. G 26209, Guthman No. 4873	2					*	*
C ₃₈	3C1090-7	COIL: r-f; 12-mh; single winding; 2.5-3.2-mc; (crystal coil); Hallcrafters No. 51A451, Detrola No. G 26203, Guthman No. 4882	1					*	*
L ₁₀	2C8049	TUNING UNIT TU-49	3					*	*
L ₂₈	3D9135-2	CAPACITOR: fixed; ceramic; 135-mmf ±5%; 500-v dc; tc-0.00015 mmf/mm/degree centigrade; Hallcrafters No. 47A010, Detrola No. G 26110	1					*	*
L ₁₆	3C1090-2	COIL: r-f; 41.0-mh; tapped; 3.2-4.0-mc; (master oscillator coil); Hallcrafters No. 51A469, Detrola No. G 26216, Guthman No. 4848	1					*	*
L ₁₁	3C1090-14	COIL: r-f; 20.6-mh; single winding; 3.2-4.0-mc; (doubler buffer coil); Hallcrafters No. 51A458, Detrola No. G 26210, Guthman No. 4874	2					*	*
C ₄₆	3C1090-8	COIL: r-f; 9.2-mh; single winding; 3.2-4.0-mc; (crystal coil); Hallcrafters No. 51A452, Detrola No. G 26204, Guthman No. 4883	1					*	*
C ₃₉	2C8050	TUNING UNIT TU-50	3					*	*
L ₁₇	3D9100-64	CAPACITOR: fixed; mica; 100-mmf ±10%; 500-v dc; C-D type 5W	1					*	*
L ₁₁	3D9170-1	CAPACITOR: ceramic; 170-mmf ±5%; 500-v dc; tc-0.00015 mmf/mm/degree centigrade; Hallcrafters No. 47A012, Detrola No. G 26103	1					*	*
L ₂₉	3C1090-9	COIL: r-f; 66.0-mh; single winding; 4.0-5.0-mc; (crystal coil); Hallcrafters No. 51A453, Detrola No. G 26205, Guthman No. 4884	1					*	*
L ₃₀	3C1090-3	COIL: r-f; 21.4-mh; tapped; 4.0-5.0-mc; (master oscillator coil); Hallcrafters No. 51A470, Detrola No. G 26217, Guthman No. 4849	1					*	*
L ₃₁	3C1090-15	COIL: r-f; 12.6-mh; single winding; 4.0-5.0-mc; (doubler buffer coil); Hallcrafters No. 51A459, Detrola No. G 26211, Guthman No. 4875	2					*	*

35.1. Maintenance Parts List for Tuning Units TU-47 through TU-54 (contd).

NOTE: Order maintenance parts by stock number, name, and description.
Only maintenance parts listed can be requisitioned.

Ref Symbol	Signal Corps Stock No.	Name of part and description	Quantity per unit	Running spares	Orgn stock	3d ech	4th ech	5th ech	Depot stock
C ₃₁ -C ₃₂	3D9140V-7	ADDITIONAL MAINTENANCE PARTS FOR ALL TUNING UNITS.	2				*	*	*
C ₃₂	3D9040-10	CAPACITOR: variable; air; 140-mmfm max; Johnson 140K8.	3				*	*	*
C ₄₅	3D9400-16	CAPACITOR: fixed; ceramic; 40-mmfm = 5%; 500-v dc; tc-0.00015 mmf/mmfd/degree centigrade; Hallicrafters No. 47A019, Detrola No. G 26106.	1				*	*	*
C ₃₄	3D9100V-9	CAPACITOR: mica; 400-mmfm = 10%; 500-v dc; C-D type 5W.	1				*	*	*
C ₃₃	3D9100V-8	CAPACITOR: variable; air; 100-mmfm max; Bud MC 1855.	1				*	*	*
C ₄₃	3D9050-61	CAPACITOR: variable; air; 100-mmfm max; Johnson 100K8.	1				*	*	*
L ₂₄ -L ₃₀	3C1090-16	CAPACITOR: fixed; ceramic; 50-mmfm = 5%; 500-v dc; tc-0.00015 mmf/mmfd/degree centigrade; Hallicrafters No. 47A049, Detrola No. G 26115.	2				*	*	*
R ₂₉ ² -R ₃₀ ²	2Z3717.5	COIL: r-f; 12.6-mh; single winding; Hallicrafters No. 51A460, Detrola No. G 26212.	1				*	*	*
R ₃₁ -R ₃₂	3Z4540	DIAL ASSEMBLY: tuning box; scale 0-100; (includes knob); Hallicrafters No. 88A155, Detrola No. G 27058.	4				*	*	*
SW ₁₅	2Z8672.25 3Z9858-3	RESISTOR: 30,000-ohm = 10%; 1/2-watt; IRC BT $\frac{1}{2}$, RC21BE303J. SOCKET: (crystal holder); Hallicrafters No. 6A004, Detrola No. G 25203. SWITCH: toggle; double-pole double-throw; bakelite; H & H 81012.	1 1				*	*	*

*Indicates stock available.

35.2. Maintenance Parts List for Speech Amplifier BC-614-E.

NOTE: Order maintenance parts by stock number, name, and description.
Only maintenance parts listed can be requisitioned.

Ref Symbol	Signal Corps Stock No.	Name of part and description	Quantity per unit	Running spares	Orgn stock	3d ech	4th ech	5th ech	Depot stock
C ₁₀₁	3DA1-41	CAPACITOR: fixed; paper, 10,000-mmf ±20%; 600-v dc; (same as C ₁₂₁); Solar XM-6-21.	2				*	*	*
C ₁₀₂	3DA10-128	CAPACITOR: fixed; paper, 10,000-mmf ±10%; 600-v dc; (same as C ₁₀₃ , C ₁₀₅ , C ₁₀₆ , C ₁₁₄ , C ₁₁₉ , C ₁₂₅ , and C ₁₂₆); Solar MP 4135.	8				*	*	*
C ₁₀₃		CAPACITOR: same as C ₁₀₂ .							
C ₁₀₄	3DB10-21	CAPACITOR: fixed; electrolytic; 10-mf -10% +40%; 25-v dc; one section of four-section unit; (see C ₁₀₇ , C ₁₁₀ , and C ₁₂₀); Industrial Cond. 1B99.	1				*	*	*
C ₁₀₅		CAPACITOR: same as C ₁₀₂ .							
C ₁₀₆		CAPACITOR: same as C ₁₀₄ .							
C ₁₀₇		CAPACITOR: same as C ₁₀₄ .							
C ₁₀₈	3DB8-35	CAPACITOR: fixed; electrolytic; dual; 8-8-mf -10% +40%; 475-v dc; one section of dual unit; (same as C ₁₀₉ , C ₁₁₁ , C ₁₁₂ , C ₁₁₃ , and C ₁₁₅); Industrial Cond. 40B233.	3				*	*	*
C ₁₀₉		CAPACITOR: same as C ₁₀₈ ; one section of dual unit.							
C ₁₁₀		CAPACITOR: fixed; electrolytic; 30-mf -10% +40%; 25-v dc; one section of four-section unit; (see C ₁₀₄).							
C ₁₁₁		CAPACITOR: same as C ₁₀₈ ; one section of dual unit.							
C ₁₁₂		CAPACITOR: same as C ₁₀₈ ; one section of dual unit.							
C ₁₁₃		CAPACITOR: same as C ₁₀₈ ; one section of dual unit.							
C ₁₁₄		CAPACITOR: same as C ₁₀₂ .							
C ₁₁₅		CAPACITOR: same as C ₁₀₈ ; one section of dual unit.							
C ₁₁₆	3DA350-5	CAPACITOR: fixed; 0.035-mf ±10%; 400-v dc; bathtub-type; Industrial Cond. 7476.	2				*	*	*
C ₁₁₇	3DA2-71	CAPACITOR: fixed; mica; 2,000-mmf ±10%; 500-v dc; (same as C ₁₁₈); Aerovox 1467.	2				*	*	*
C ₁₁₈		CAPACITOR: same as C ₁₁₇ .							
C ₁₁₉		CAPACITOR: same as C ₁₀₂ .							
C ₁₂₀		CAPACITOR: same as C ₁₁₀ ; one section of four-section unit.							
C ₁₂₁		CAPACITOR: same as C ₁₀₁ .							
C ₁₂₂	3DA2-46	CAPACITOR: fixed; paper; 2,000-mmf ±20%; 600-v dc; type 340; (same as C ₁₂₃ and C ₁₂₅); Dubilier 4LS012020.	3				*	*	*
C ₁₂₃		CAPACITOR: same as C ₁₂₂ .							
C ₁₂₄		CAPACITOR: same as C ₁₁₆ .							
C ₁₂₅		CAPACITOR: same as C ₁₀₂ .							
C ₁₂₆		CAPACITOR: same as C ₁₀₂ .							
C ₁₂₇	3DA5-27	CAPACITOR: fixed; mica; 5,000-mmf ±5%; 300-v dc; (same as C ₁₂₉ and C ₁₃₀).	3				*	*	*
C ₁₂₈		CAPACITOR: same as C ₁₂₂ .							
C ₁₂₉		CAPACITOR: same as C ₁₂₇ .							
C ₁₃₀		CAPACITOR: same as C ₁₂₇ .							

35.2. Maintenance Parts List for Speech Amplifier BC-614-E (contd).

NOTE: Order maintenance parts by stock number, name, and description.
Only maintenance parts listed can be requisitioned.

Ref Symbol	Signal Corps Stock No.	Name of part and description	Quantity per unit	Running spares	Orgn stock	3d ech	4th ech	5th ech	Depot stock
CH ₁₀₁	3C548	REACTOR: iron core; 29-henry; GTC 1C103	1				*	*	*
J ₁₀₁	2Z5524	JACK JK-24: single-circuit; standard headphone type	1				*	*	*
J ₁₀₂	2Z5522	JACK JK-22: 3-circuit; telephone-type	1				*	*	*
LM ₁₀₁	2Z5927	LAMP LM-27: 6-8-v; 0.25-amp; miniature bayonet base; type 44	1	1			*	*	*
M ₁₀₁	3F930-10	MILLIAMETER: 0-300-ma dc; type DO-53	1				*	*	*
R ₁₀₁	3Z6801-16	RESISTOR: fixed; 1-megohm $\pm 20\%$; $\frac{1}{2}$ -watt; (same as R ₁₀₂); IRC BT $\frac{1}{2}$, RC21BE1105M	2				*	*	*
R ₁₀₂		RESISTOR: same as R ₁₀₁					*	*	*
R ₁₀₃	3Z6270-6	RESISTOR: fixed; 200,000-ohm $\pm 10\%$; $\frac{1}{2}$ -watt; IRC BT $\frac{1}{2}$, RC21BE204J	2				*	*	*
R ₁₀₄	3Z6010-31	RESISTOR: fixed; 100-ohm $\pm 10\%$; $\frac{1}{2}$ -watt; IRC BT $\frac{1}{2}$, RC21BE101K	1				*	*	*
R ₁₀₅	3Z4525	RESISTOR: fixed; 1,000-ohm $\pm 10\%$; $\frac{1}{2}$ -watt; (same as R ₁₀₆); IRC BT $\frac{1}{2}$, RC21BE102K	3				*	*	*
R ₁₀₆		RESISTOR: same as R ₁₀₅					*	*	*
R ₁₀₇	3Z4550	RESISTOR: fixed; 100,000-ohm $\pm 10\%$; $\frac{1}{2}$ -watt; (same as R ₁₁₃ , R ₁₁₆ , and R ₁₁₇); IRC BT $\frac{1}{2}$, RC21BE104K	4				*	*	*
R ₁₀₉	3Z4533	RESISTOR: fixed; 500,000-ohm $\pm 10\%$; $\frac{1}{2}$ -watt; (same as R ₁₃₂); IRC BT $\frac{1}{2}$, RC21BE514J	2				*	*	*
R ₁₁₀	3Z4562	RESISTOR: fixed; 250,000-ohm $\pm 10\%$; $\frac{1}{2}$ -watt; (same as R ₁₁₄ , R ₁₁₈ , R ₁₁₉ , R ₁₂₀ , and R ₁₃₃); IRC BT $\frac{1}{2}$, RC21BE244J	6				*	*	*
R ₁₁₁	2Z7298-3	POTENTIOMETER: 1 megohm; 1-watt; CRL 1-01-1602	2				*	*	*
R ₁₁₂		RESISTOR: same as R ₁₀₃					*	*	*
R ₁₁₃		RESISTOR: same as R ₁₀₇					*	*	*
R ₁₁₄		RESISTOR: same as R ₁₁₀					*	*	*
R ₁₁₅	3Z6050-53	RESISTOR: fixed; 500-ohm $\pm 10\%$; 1-watt; (same as R ₁₂₁); IRC BW1, RC31BE511J	2				*	*	*
R ₁₁₆		RESISTOR: same as R ₁₀₇					*	*	*
R ₁₁₇		RESISTOR: same as R ₁₀₇					*	*	*
R ₁₁₈		RESISTOR: same as R ₁₁₀					*	*	*
R ₁₁₉		RESISTOR: same as R ₁₁₀					*	*	*
R ₁₂₀		RESISTOR: same as R ₁₁₀					*	*	*
R ₁₂₁		RESISTOR: same as R ₁₁₅					*	*	*
R ₁₂₂	3Z4526	RESISTOR: fixed; 2,000-ohm $\pm 10\%$; $\frac{1}{2}$ -watt; IRC BT $\frac{1}{2}$, RC21BE202J	1				*	*	*
R ₁₂₃		RESISTOR: same as R ₁₁₁					*	*	*
R ₁₂₄	3Z6030-11	RESISTOR: fixed; 300-ohm $\pm 10\%$; 1-watt; IRC BW1, RCBE301J	1				*	*	*
R ₁₂₅	3Z6675-10	RESISTOR: fixed; 75,000-ohm $\pm 10\%$; 2-watt; IRC BT2, RC41BE753J	1				*	*	*
R ₁₂₆	3Z6620-12	RESISTOR: fixed; 20,000-ohm $\pm 10\%$; 2-watt; IRC BT2, RC41BE203J	1				*	*	*
R ₁₂₇	3Z66508	RESISTOR: fixed; 50,000-ohm $\pm 10\%$; 1-watt; (same as R ₁₂₈); IRC BT1, RC31BE513J	2				*	*	*
R ₁₂₈		RESISTOR: same as R ₁₂₇					*	*	*
R ₁₂₉	3Z6620-46	RESISTOR: fixed; 20,000-ohm $\pm 10\%$; $\frac{1}{2}$ -watt; IRC BT $\frac{1}{2}$	1				*	*	*

R ₁₃₀	3Z4531	RESISTOR: fixed; 50,000 ohm = 10%; 1/2-watt; (same as R ₁₃₈); IRC BT 1/2, RC21BE513J	2	*	*	*
R ₁₃₁		RESISTOR: same as R ₁₀₅		*	*	*
R ₁₃₂		RESISTOR: same as R ₁₀₉		*	*	*
R ₁₃₃	3Z4593	RESISTOR: fixed; 3-megohm = 10%; 1/2-watt; IRC BT 1/2, RC21BE305J	1	*	*	*
R ₁₃₄	2Z7298-4	POTENTIOMETER: 500,000-ohm; CRL 1-010-1603	1	*	*	*
R ₁₃₅		RESISTOR: same as R ₁₁₀		*	*	*
R ₁₃₆	3Z4524	RESISTOR: fixed; 500-ohm = 10%; 1/2-watt; IRC BT 1/2, RC21BE511J	1	*	*	*
R ₁₃₇	2Z7231-31	RESISTOR: variable; 100,000-ohm = 20%; CRL 25C0896	1	*	*	*
R ₁₃₈		RESISTOR: same as R ₁₃₀		*	*	*
R ₁₃₉	3Z4528	RESISTOR: fixed; 5,000-ohm = 10%; 1/2-watt; (same as R ₁₄₀ and R ₁₄₁); IRC BT 1/2, RC21BE502J	4	*	*	*
R ₁₄₀		RESISTOR: same as R ₁₃₉		*	*	*
R ₁₄₁		RESISTOR: same as R ₁₃₉		*	*	*
R ₁₄₂	3Z6020-8	RESISTOR: fixed; 200-ohm = 5%; 1-watt; IRC BT1, RC31BE201J	1	*	*	*
SO ₁₀₁	2Z8658	SOCKET: female; 3-contact; (chassis connector); Amphenol PC3F	1	*	*	*
SO ₁₀₂	2Z8678-13	SOCKET: octal; (chassis connector); Amphenol PO8-F 10B040	1	*	*	*
SO ₁₀₃	2Z7118-20	SOCKET: male; octal; Amphenol PO8M-1	1	*	*	*
T ₁₀₁	2Z9631-3	TRANSFORMER: a-f; microphone; (2 windings; 125-ohm pri; 125-ohm sec); GTC 2D-131	1	*	*	*
T ₁₀₂	2Z9632-4	TRANSFORMER: a-f; audio output; (2 windings; 18,000-ohm pri; 500-ohm sec); GTC 2D-99	1	*	*	*
T ₁₀₃	2Z9613-2	TRANSFORMER: filament and plate; (pri 117-v ac; sec (1) 500-v ac ct 25-ma; (2) 6.3-v ac ct 2-amp; (3) 5-v ac 2-amp); GTC 5C160	1	*	*	*
T ₁₀₄	2Z9634-2	TRANSFORMER: a-f; modulator limiter; (2 windings; 10,000-ohm pri; 80,000-ohm sec); GTC 2A109	1	*	*	*
	2Z1247-2	BRACKET: resistor mounting; Ohmite 12, Hallicrafters No. 67A068		*	*	*
	2Z2626-11	CLAMP, tube base and capacitor; Industrial Cond. type 11-86, Hallicrafters No. 76A029, Detrola No. G 26899	4	*	*	*
FS ₃	3Z1950	FUSE: 3-amp; 250-v; type 3AG; Littelfuse 1043	1	*	*	6
FS ₄	3Z1935	FUSE: 5-amp; 125-v; type 4AG; Littelfuse 1094	1	*	*	6
	6Z4856-13	GROMMET: rubber; 1/4"; Hallicrafters No. 16A013, Detrola No. G 25555	2	*	*	*
	6Z4856-14	GROMMET: rubber; 3/4"; Hallicrafters No. 16A026, Detrola No. G 25556	2	*	*	*
	2Z5849-10	KNOB: with skirt; 1 1/8" diam; Hallicrafters No. 83A153, Detrola No. G 27057	2	*	*	*
	2Z5882-6	LIGHT: pilot; red; assembly; Hallicrafters No. 86A016, Detrola No. G 27104	1	*	*	*
R _{21-R₂₂}	3Z6005-44	RESISTOR: fixed; 50-ohm = 10%; 1/2-watt; IRC BT 1/2, RC21BE510J	2	*	*	*
	3Z4540	RESISTOR: fixed; 30,000-ohm = 10%; 1/2-watt; IRC BT 1/2, RC21BE303J	3	*	*	*
	3Z6650-7	RESISTOR: fixed; 50,000-ohm = 10%; 1/2-watt; IRC BT 1/2, RC41BE513J	1	*	*	*
	3Z6715-17	RESISTOR: fixed; 150,000-ohm = 10%; 1/2-watt; IRC BT 1/2, RC41BE154K	1	*	*	*
	2Z8659-7	SOCKET: 6-prong; bakelite; rivet mounting; Amphenol MIP-6		*	*	*
	2Z8659-6	SOCKET: tube; octal; bakelite; rivet mounting; Amphenol MIP-6	6	*	*	*
	2T103	TUBE VT-103	1	*	*	*
V ₁₀₁	2T94	TUBE VT-94: same as V ₁₀₃	2	*	*	*
V ₁₀₂	2T103	TUBE VT-231: same as V ₁₀₄ and V ₁₀₆	3	*	*	*
V ₁₀₃		TUBE: same as V ₁₀₃		*	*	*
V ₁₀₄	2T133	TUBE VT-233	1	*	*	*
V ₁₀₅		TUBE: same as V ₁₀₃		*	*	*
V ₁₀₆	2T80	TUBE VT-80	1	*	*	*
V ₁₀₇		TUBE: same as V ₁₀₃		*	*	*
V ₁₀₈		TUBE: same as V ₁₀₃		*	*	*

*Indicates stock available.

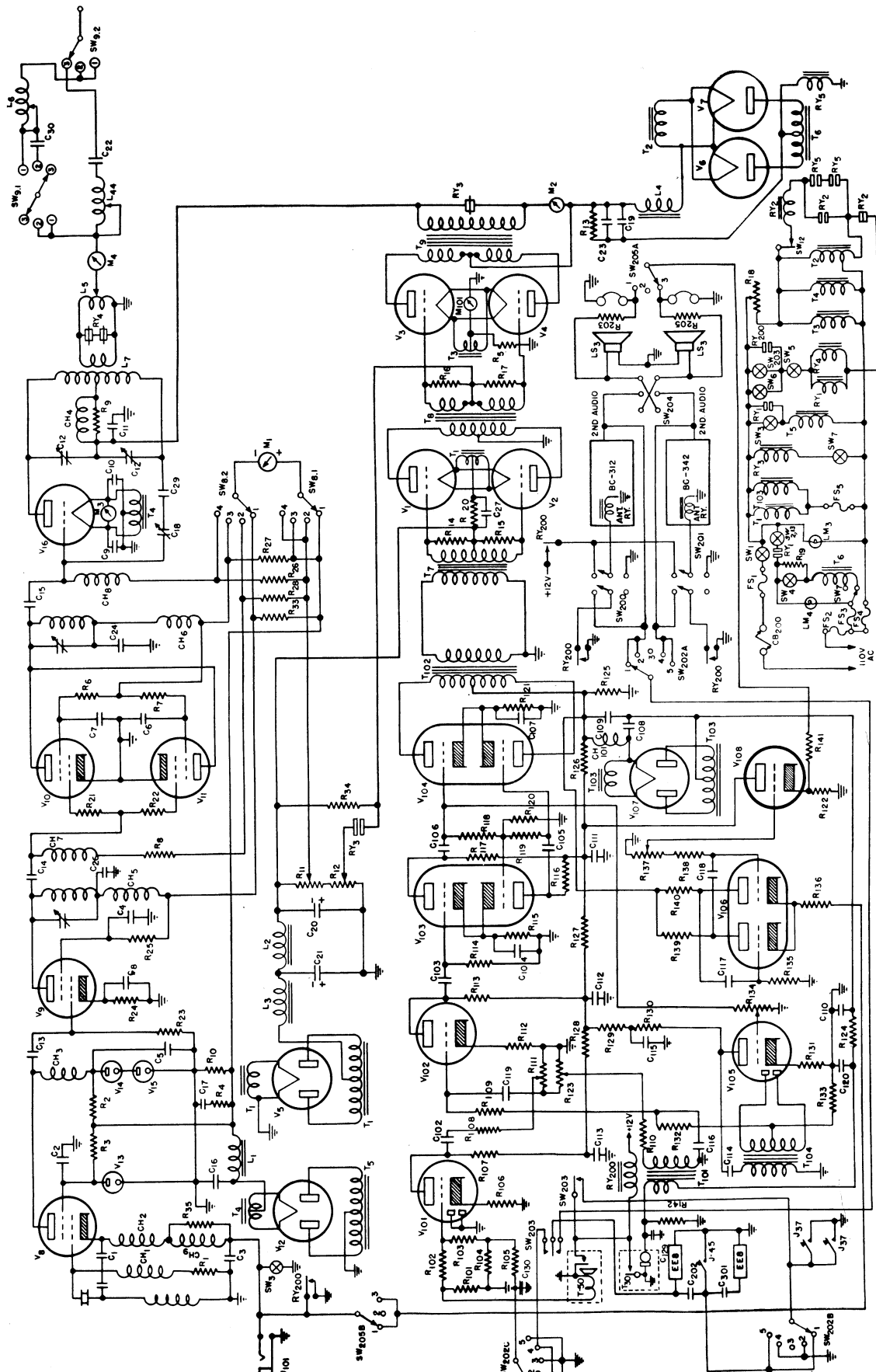

Figure 17A—Revised Radio Sets SCR-399-(*) and SCR-499-(*), over-all schematic circuit diagram, simplified

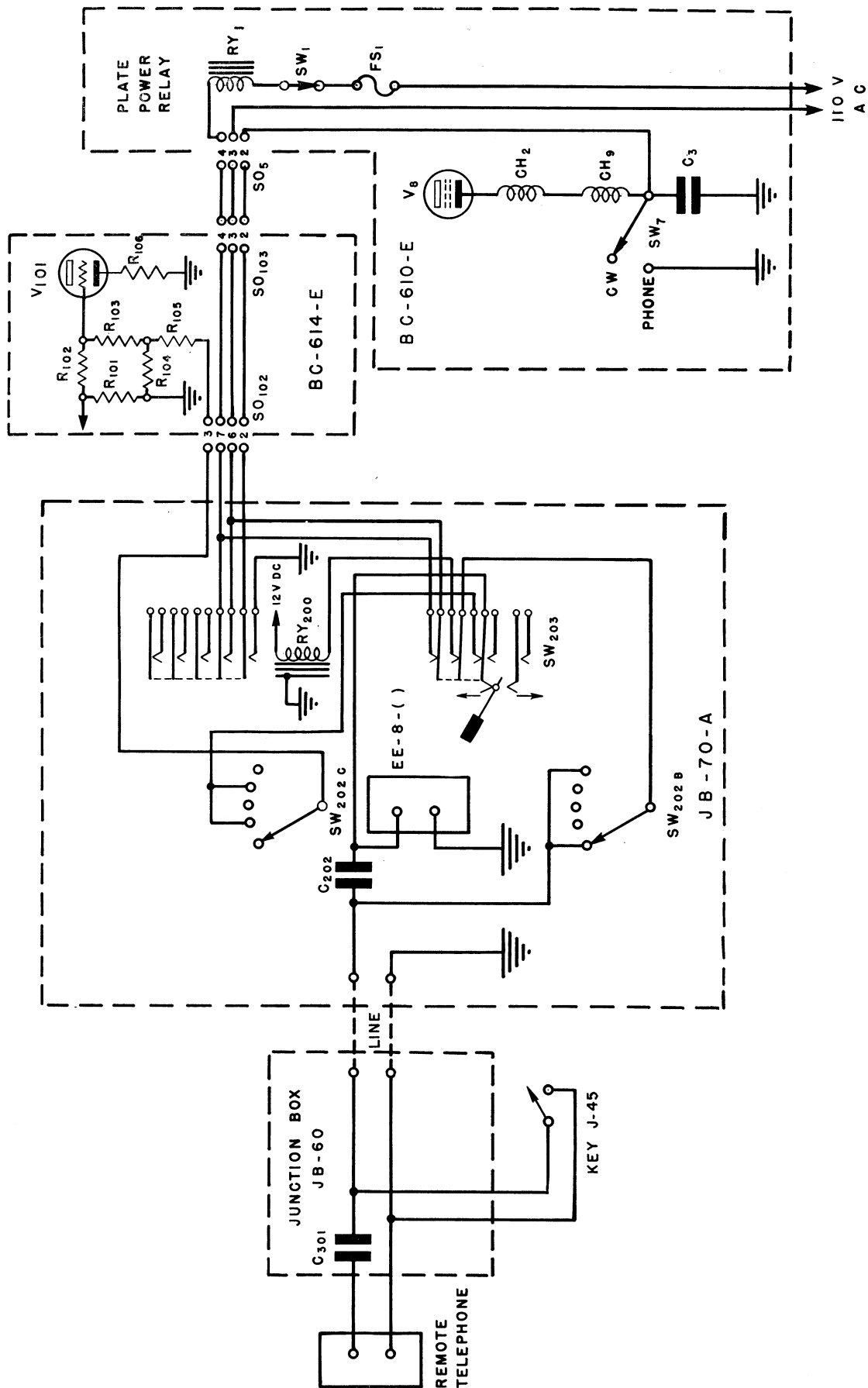
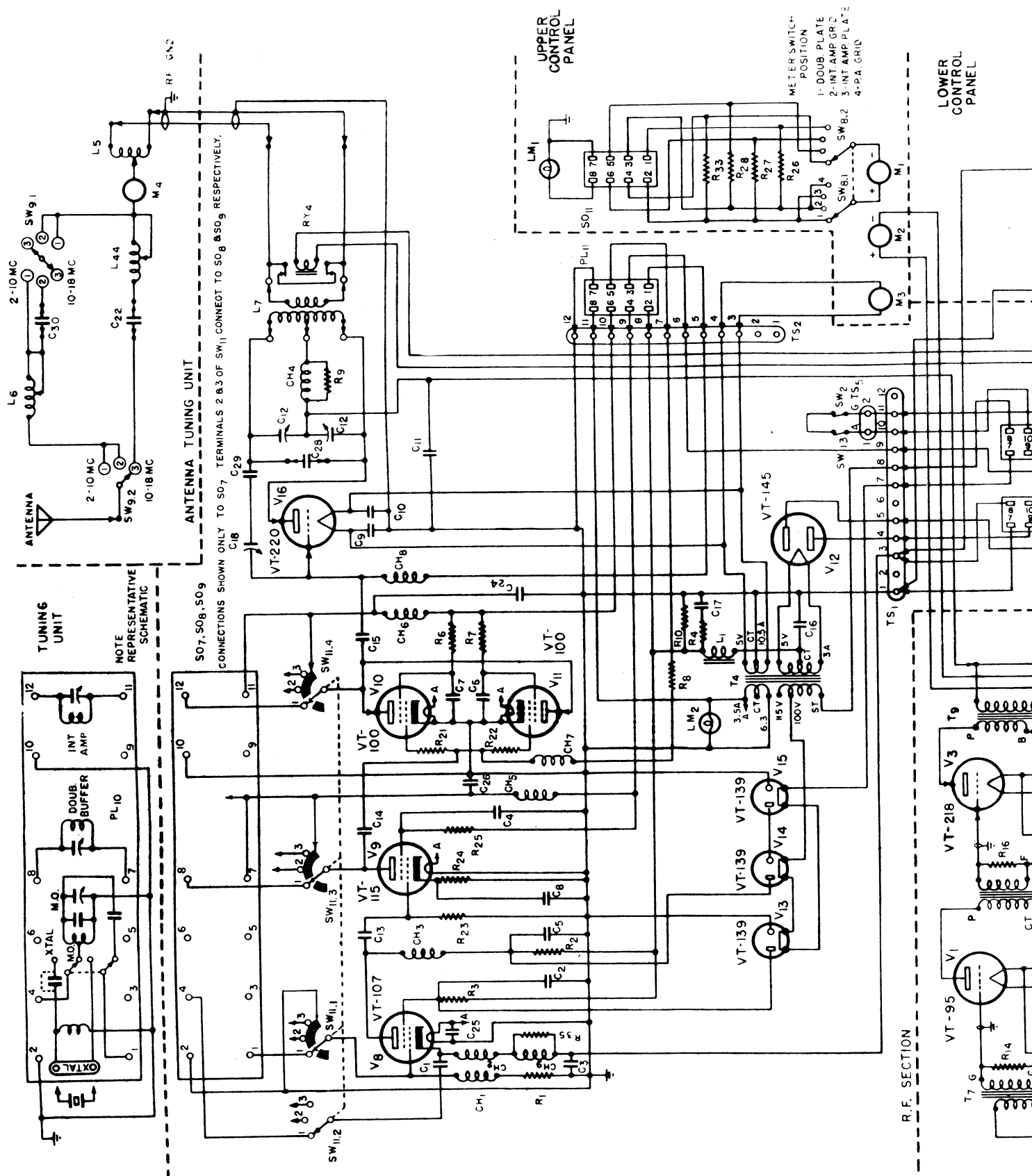

Figure 25A—Revised Functional diagram of remote operation







Figure

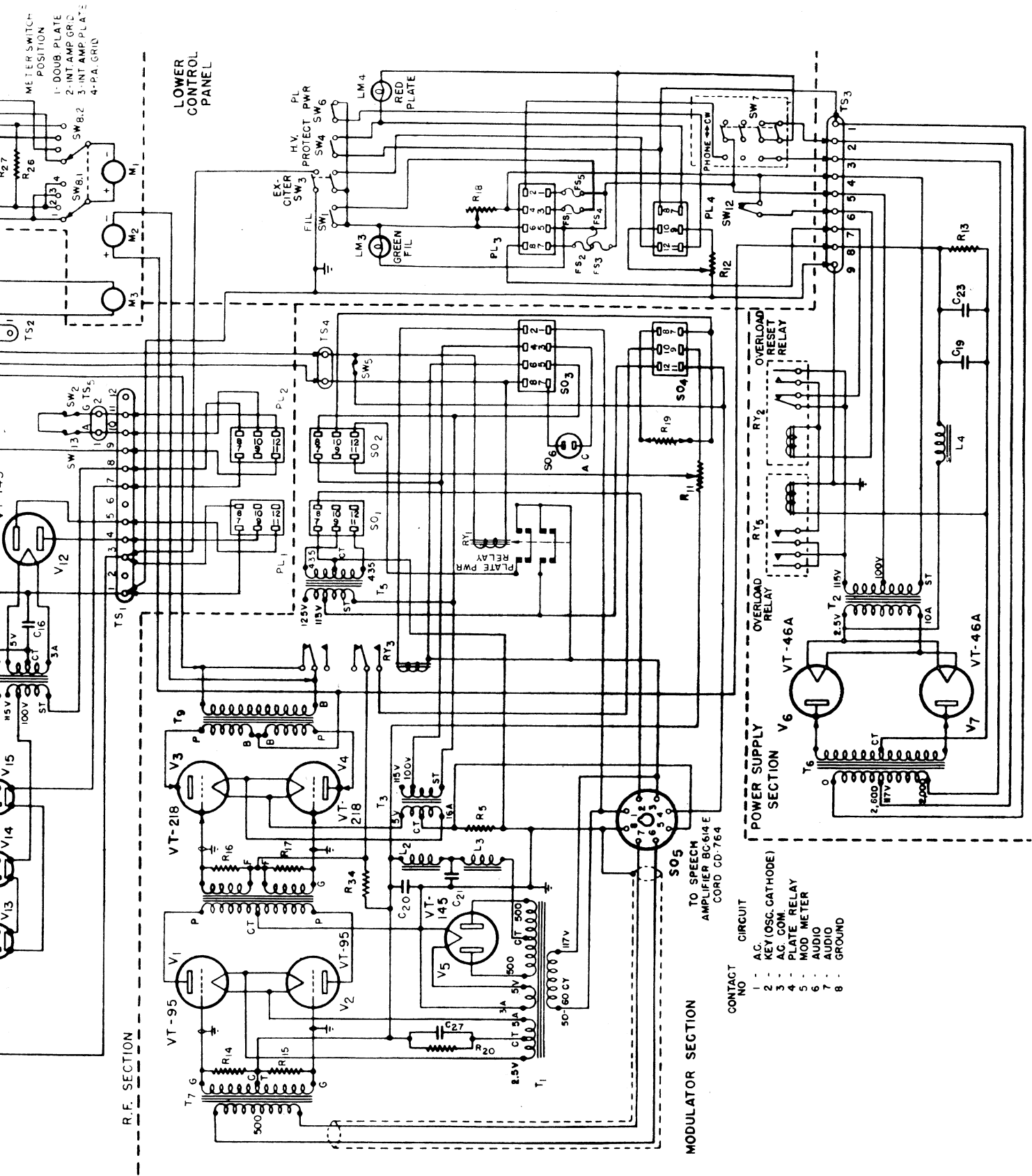

Figure 19A—Revised Radio Transmitter BC-610-E and Antenna Unit BC-939-A, schematic wiring diagram

PRINTED
IN
U.S.A.

S. C. ORDER 26804-PHILA-44-07

X-38011 1800 10-44 TYPO

RESTRICTEDTECHNICAL MANUAL }
NO. 11-281 }WAR DEPARTMENT
Washington 25, D. C., 4 September 1943**RADIO SETS SCR-399-A AND SCR-499-A†**Prepared under direction of
Chief Signal Officer**TABLE OF CONTENTS**

SECTION I. DESCRIPTION

	<i>Paragraph</i>
General Characteristics	1
Over-all Description	2
Tactical Adaptability	3
Frequency Coverage	4
Range of Operation	5
Source of Power	6
Main Components	7
Brief Description of Principal Units and Major Components	8
Alphabetical Tabulation of Components	9

SECTION II. INSTALLATION AND OPERATION

Installation of Radio Set SCR-399-(*) in Shelter HO-17-(*)	10
Installation of Radio Set SCR-499-(*) for Field Operation	11
Preparation for Use of Radio Set SCR-399-(*)	12
Preparation for Use of Radio Set SCR-499-(*)	13
Precautions Before Operating	14
Transmitting	15
Reception	16
Battery System	17

SECTION III. FUNCTIONING OF PARTS

Radio Transmitter BC-610-E	18
Antenna Tuning Unit BC-939-A	19
Speech Amplifier BC-614-E	20
Junction Box JB-70-A	21

SECTION IV. MAINTENANCE

Regular Inspection and Service	22
Removal of Equipment	23
Procedure in Case of Equipment Failure	24
Locating Trouble	25
Normal Voltage Readings	26
Cleaning Crystals	27
Access to Components	28
Neutralization	29
Modulation Limiter	30
Use of Analyzer BC-1052-E	31

SECTION V. SUPPLEMENTARY DATA

Table of Tuning Components	32
Table of Tuning Ranges for Long Wire Antennae	33
Chart of Performance Characteristics	34
Table of Replaceable Parts	35
List of Manufacturers	36

NOTE: This Technical Manual Supersedes TM 11-281 dated April 17, 1943 and
TM 11-281-(), undated.

† The Signal Corps Stock No. of this Technical Manual TM 11-281 is 6D13127.

LIST OF ILLUSTRATIONS

	<i>Page</i>
Figure 1—Radio Set SCR-399-(*) in Shelter HO-17-(*) exterior view, installed on vehicle	4
Figure 2—Radio Set SCR-399-(*) in Shelter HO-17-(*), external components	6
Figure 3—Radio Set SCR-399-(*), inside view, showing operating position	8
Figure 4—Radio Set SCR-399-(*), inside view, showing accessory components	10
Figure 5—Radio Sets SCR-399-(*) and SCR-499-(*), operating components set up for field use	12
Figure 6—Radio Sets SCR-399-(*) and SCR-499-(*), accessory components	14
Figure 7—Trailer K-52-E (power equipment) with covers removed	16
Figure 8—Radio Transmitter BC-610-E, with Antenna Tuning Unit BC-939-A, front view	18
Figure 9—Chest CH-120-A (main operating), front view, with legs	20
Figure 10—Chest CH-121-A (auxiliary operating), with Chest CH-109-A, for field operation	22
Figure 11—Speech Amplifier BC-614-E, and Junction Box JB-70-A, front view	24
Figure 12—Bumper bracket for Cord CO-335, installed on bumper of 2½ ton 6x6 truck	26
Figure 13—Front end of truck installation, showing ground connection and speaking tube	28
Figure 14—Radio Transmitter BC-610-E, top view, cover removed	30
Figure 15—Antenna Tuning Unit BC-939-A, top view (cover removed)	32
Figure 16—Radio Sets SCR-399-(*) and SCR-499-(*), cording diagram	70
Figure 17—Radio Sets SCR-399-(*) and SCR-499-(*), over-all schematic circuit diagram, simplified	71
Figure 18—Tuning Units for Radio Transmitter BC-610-E, schematic wiring diagram	72
Figure 19—Radio Transmitter BC-610-E and Antenna Unit BC-939-A, schematic wiring diagram	73
Figure 20—Speech Amplifier BC-614-E, schematic wiring diagram	74
Figure 21a—Junction Box JB-70-A, schematic wiring diagram	75
Figure 21b—Revised Junction Box JB-70-A, schematic wiring diagram	76
Figure 22—Tube socket layout showing voltages	77
Figure 23—Functional diagram of voice operation	78
Figure 24—Functional diagram of c-w operation	79
Figure 25—Functional diagram of remote operation	80
Figure 26—Functional diagram of oscillator circuits	81
Figure 27—Tuning Chart of Tuning Unit TU-47	82
Figure 28—Tuning Chart of Tuning Unit TU-48	83
Figure 29—Tuning Chart of Tuning Unit TU-49	84
Figure 30—Tuning Chart of Tuning Unit TU-50	85
Figure 31—Tuning Chart of Tuning Unit TU-51	86
Figure 32—Tuning Chart of Tuning Unit TU-52	87
Figure 33—Tuning Chart of Tuning Unit TU-53	88
Figure 34—Tuning Chart of Tuning Unit TU-53—(Cont'd.)	89
Figure 35—Tuning Chart of Tuning Unit TU-54	90
Figure 36—Tuning Chart of Tuning Unit TU-54—(Cont'd.)	91

DESTRUCTION OF ABANDONED MATERIEL IN THE COMBAT ZONE

In case it should become necessary to prevent the capture of this equipment, and when ordered to do so, **DESTROY IT SO THAT NO PART OF IT CAN BE SALVAGED, RECOGNIZED, OR USED BY THE ENEMY. BURN ALL PAPERS AND BOOKS.**

BY:

1. Explosives, when provided.
2. Hammers, axes, sledges, or whatever heavy objects are readily available.
3. Burning with gasoline, oil, paper, or wood.
4. Grenades and shots from available arms.

PROCEDURE:

1. Obliterate all identifying marks. Destroy nameplates and circuit labels.
2. Demolish all panels, castings, switch- and instrument-boards.
3. Destroy all controls, switches, relays, connecting means and meters.
4. Rip out all wiring in electrical equipment. Smash water-cooling, gas and oil systems in gas-engine generators, etc.
5. Smash every electrical or mechanical part whether rotating, moving or fixed.
6. Break up all operating instruments such as keys, phones, microphones, etc.
7. Destroy all classes of carrying cases, straps, containers, etc.

DISPOSAL:

1. Where possible, and when time permits, bury all debris or dispose of it in streams or other bodies of water.

SAFETY NOTICE

This equipment employs HIGH VOLTAGES which are DANGEROUS TO LIFE. Electrical interlock switches are provided for your protection. They remove the high d-c voltage to the output circuits in the transmitter when the hinged doors of the cover are open or when either the cover or the back is removed. Always be sure that back, cover and cover doors are closed BEFORE APPLYING PLATE POWER.

When the transmitter is in operation EXTREMELY HIGH R-F VOLTAGES are present in and around the antenna tuning unit, all its connecting leads, the antenna and the antenna insulator. You can get DANGEROUS BURNS from arcs caused by touching the ANTENNA CIRCUIT. BE CAREFUL! Do not attempt to make an adjustment unless you are thoroughly familiar with this equipment.

DO NOT FILL GASOLINE TANKS OF TRUCK OR POWER UNIT WHILE THE TRANSMITTER IS WORKING. The difference in r-f potential between the truck or trailer and ground can cause a spark that will explode gasoline or gas fumes always present around gas-engine type power units.

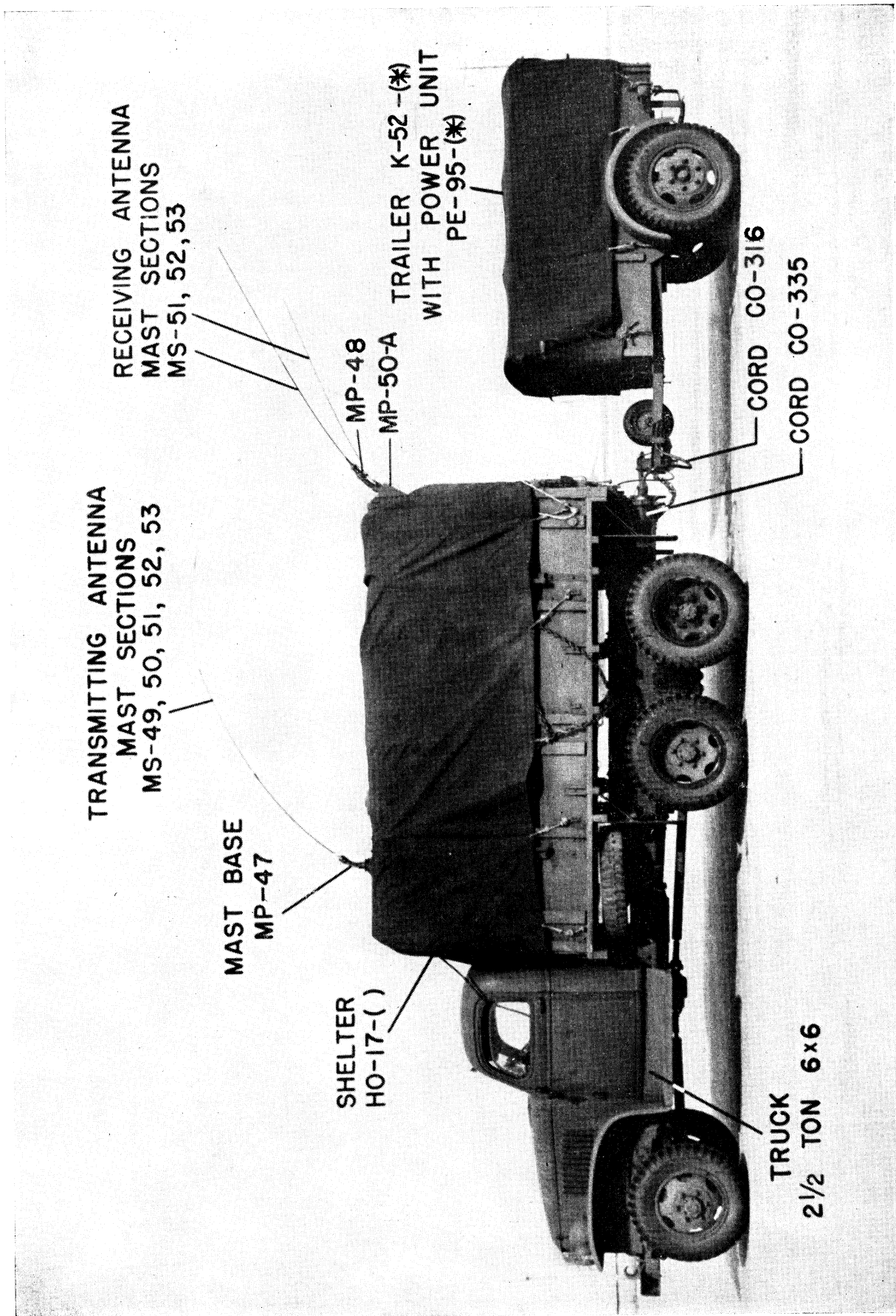

Figure 1—Radio Set SCR-399-A in Shelter HO-17-(*) exterior view, installed on vehicle

SECTION I—DESCRIPTION

	<i>Paragraph</i>
General Characteristics	1
Over-all Description	2
Tactical Adaptability	3
Frequency Coverage	4
Range of Operation	5
Source of Power	6
Main Components	7
Brief Description of Principal Units and Major Components	8
Alphabetical Tabulation of Components	9

This manual covers Radio Set SCR-399-(*) with components installed in Shelter HO-17-(*) (mobile) and Radio Set SCR-499-(*) with components packaged for shipment (air-borne). Since the components of both sets are identical the text will refer entirely to Radio Set SCR-399-(*) except where special handling or setup is necessary with Radio Set SCR-499-(*), in which case special paragraphs are included. Other technical manuals or instructions which are necessary for the complete understanding of Radio Sets SCR-399-(*) and SCR-499-(*) are as follows:

TM 11-333 for Telephones EE-8-(*).

TM 11-850 for Radio Receivers BC-312-(*), BC-314-(*), BC-342-(*), and BC-344-(*).

TM 11-904 for Power Unit PE-95-(*).

TM 11-300 for Frequency Meter SCR-211-(*).

Instruction Leaflet for Shelter HO-17-(*).

Trailers and power units as supplied with Radio Sets SCR-299-A, SCR-299-B, SCR-299-C, and SCR-299-D are interchangeable with those used on Radio Sets SCR-399-(*) and SCR-499-(*).

1. General Characteristics.—Radio Set SCR-399-(*) is a high power, vehicular radio station providing voice or c-w communication over a range of more than 100 miles depending on conditions of atmosphere and terrain, either from a stationary position, or while moving at high speeds over rough roads. This radio set consists of a completely equipped radio station normally installed in Shelter HO-17-(*), combined with a power plant normally carried in a one-ton cargo Trailer K-52-E. The shelter is usually installed on a motor vehicle.

NOTE: Throughout this manual an asterisk within parentheses denotes the applicable issue letter.

2. Over-all Description.

a. Radio Set SCR-399-(*) installed in Shelter HO-17-(*) is usually mounted on a 2½-ton 6 x 6 truck and accommodates a personnel of four. Two seats in the cab of the truck carry the driver and his alternate. Two operators may sit at the operating positions of the radio station inside the shelter. From here it is possible by remote control to start or stop the Power Unit PE-95-(*) located in the Trailer K-52-E. All receiving and transmitting controls, as well as tuning units, coils and crystals (when required for changing frequency) are within reach of the operating positions. Moderate temperatures can be maintained within the shelter through use of the electric heater in cold weather and the heater fan and ventilating blower in warm weather. Both are fan-driven units providing circulation regardless of whether the shelter is stationary or in motion. Sleeping quarters for one person are provided by utilizing Chest CH-89-A (seat bench) which has four inch cushions mounted on each lid covering its spare parts compartments. By removing the wooden frame and the tarpaulin from the trailer an additional shelter can be made.

b. Radio Set SCR-499-(*) includes all of the principal components of the Radio Set SCR-399-(*), except that none of the radio equipment is installed in the shelter and the power unit is not installed in a trailer. Canvas covers are provided as protection for the major radio components and the various units may be transported by air or other means to a desired destination where they may be quickly set up as a field radio station either in a tent, shelter or vehicle.

3. Tactical Adaptability.—Following is a list of features and equipment included in Radio Sets SCR-399-(*) and SCR-499-(*) to insure continuity of operation under varied circumstances as required by field or combat conditions:

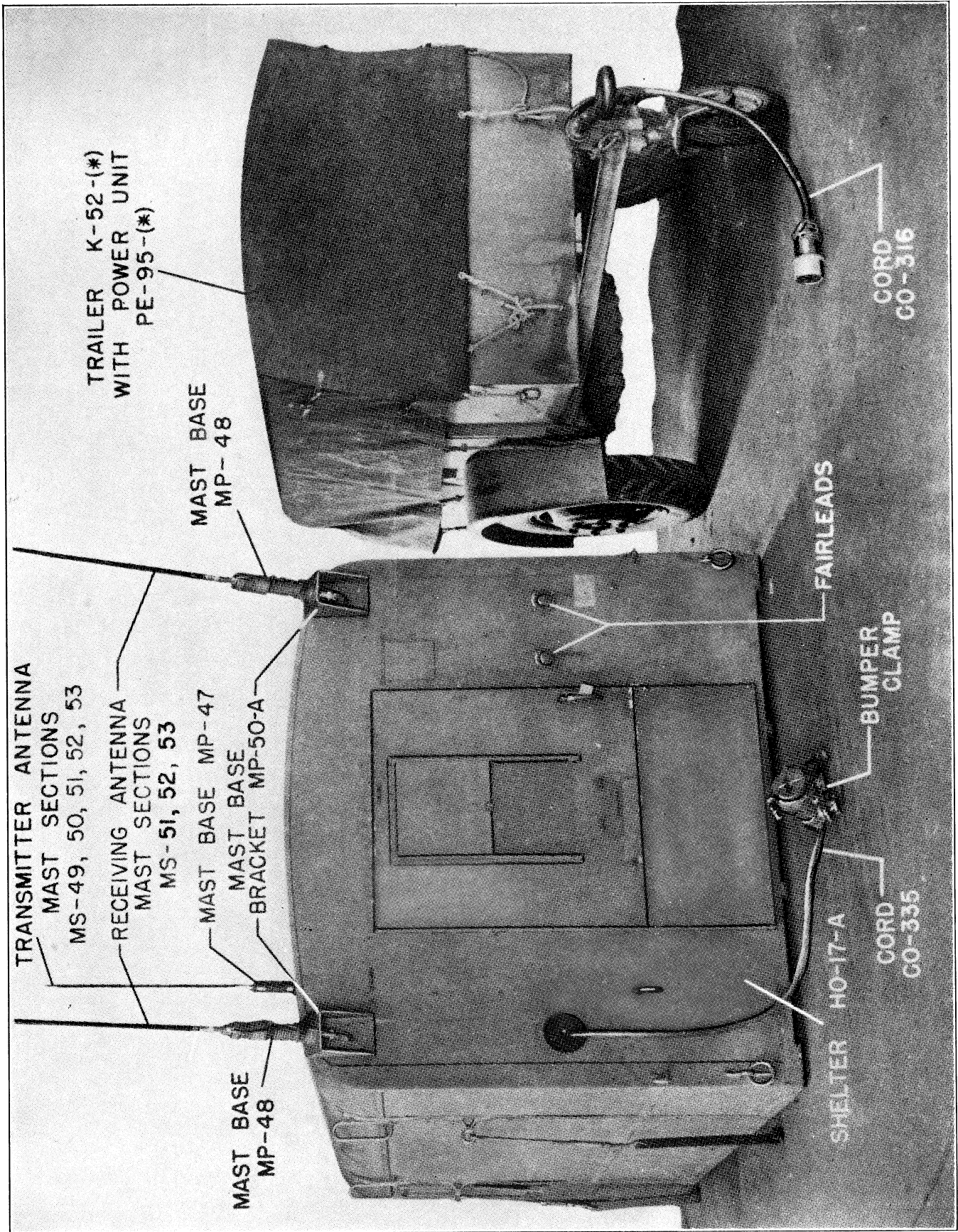

Figure 2—Radio Set SCR-399-(*) in Shelter HO-17-(*), external components

a. Inclusion of Microphones T-30-(*) (throat) permits voice modulation when helmets are worn by the operators.

b. One fire extinguisher is within reach of the operators.

c. At all times, Radio Transmitter BC-610-E may be controlled, keyed and voice modulated from either one of two positions. Break-in c-w operation is provided.

d. Remote operation is possible by removing one Telephone EE-8-(*) as much as one mile away, from which point you can modulate or key the transmitter, listen in on either Radio Receiver BC-312-(*) or BC-342-(*) and also maintain contact with the truck personnel through the other field telephone remaining in the truck.

e. Chest CH-121-A (containing Radio Receiver BC-312-(*), loudspeaker, headset, key and field telephone) together with Chest CH-109-A (containing the spare battery) may be set up as an independent field receiving station with direct telephonic communication to the shelter. The receiving operator can also use remote communication facilities as described in Paragraph 3 **d.**

f. The two Telephones EE-8-(*), together with one or both Reels DR-4, can be removed from the truck and set up as a field telephone system.

g. The Power Unit PE-95-(*) may be:

(1) operated 100 feet away from the truck by using the extension cables provided.

(2) operated 200 feet away from the truck by using two extension cables, provided that the operator walks over to the trailer to start or stop the power unit.

(3) used as source of power for lighting, etc., at a distance of up to 200 feet from the trailer.

h. If Power Unit PE-95-(*) is disabled or destroyed it is possible to:

(1) operate Radio Receiver BC-312-(*) from a 12 V storage battery.

(2) operate the entire radio station from a commercial power source using extension cables provided for that purpose.

i. When necessary, Shelter HO-17-(*) with all of the installed radio equipment may be removed from the truck and placed on the ground as a complete field radio station, with all communicating facilities intact. Both the shelter and trailer can be easily camouflaged, and if desired can be separated by extension cables. Under these conditions the truck is released completely for

other missions until such time as it is desired to again move the station.

j. The transmitter and the various chests are removable from Shelter HO-17-(*) without difficulty or employment of tools because of the extensive use of wing nuts, clasps, and turn buckles. The two operating chests are provided with a set of legs which can be attached for use in the field. Fittings on the top of the two operating chests allow the receiving antennae to be screwed directly into them. Upon removal, all of this equipment can be set up in the field, in a tent, shelter or building, or if necessary can be installed in any other vehicle of ample size and put in mobile operation by connecting to Power Unit PE-95-(*).

k. Rectifier RA-63-A, operating from the a-c source, furnishes 12 volts d-c to keep the storage battery charged. This rectifier can be used in emergency to furnish the 12-volt power directly if the storage battery is dead or being used elsewhere.

l. Using the speaking tube, the operator and the truck driver can communicate with each other while the truck is in motion. Attention is attracted by using the whistle provided at each end. Open whistle diaphragm when talking.

4. Frequency Coverage.—The transmitting components of Radio Sets SCR-399-(*) and SCR-499-(*) are capable of providing radio communication either by voice modulation or continuous waves in the frequency range from 2 to 18 megacycles; and the receiving components operate over the range 1.5 to 18 megacycles.

5. Range of Operation.—Reliable two-way voice communication is to be expected at all times of the day or year with another Radio Set SCR-399-(*) or SCR-499-(*) operating within 100 miles, while either one or both are in motion. The use of continuous wave telegraphy should increase the range to 250 miles or more. These results can be expected, provided that choice of operating frequencies be made in accordance with the time of day and time of year. If these radio sets are operating at distances less than the practical limits mentioned above, reliable two way contacts may be achieved without too critical a regard for frequencies, as a result of the inherent sensitivity of the receiving components and the high power output of the transmitting components.

6. Source of Power.—Radio Sets SCR-399-(*) and SCR-499-(*) are equipped with their own power source. Power Unit PE-95-(*) in its Trailer

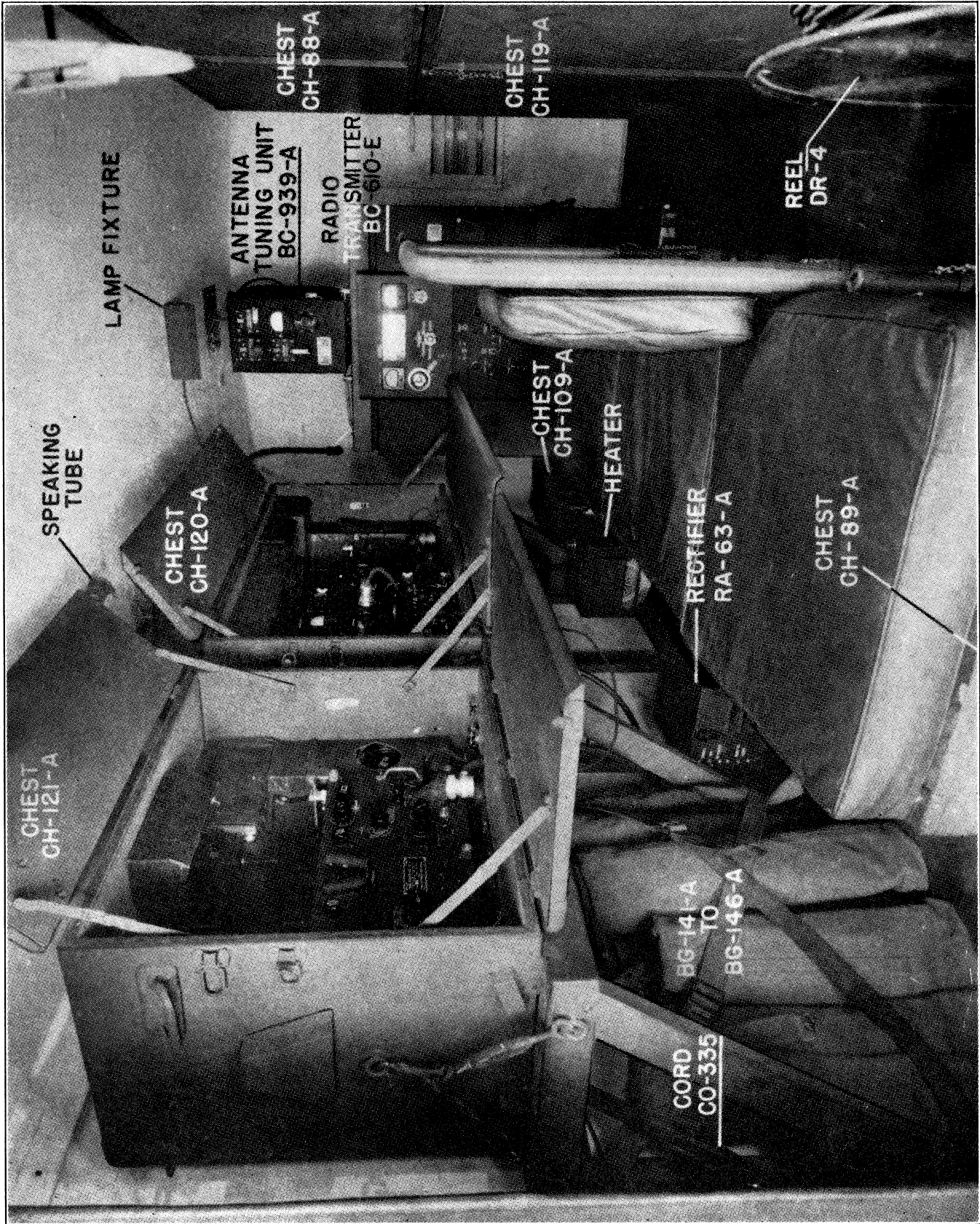

Figure 3—Radio Set SCR-399-A, inside view, showing operating position

K-52-E forms a complete self-contained mobile generating unit. This power unit delivers from its generator up to 5 kilowatts of single-phase, 60-cycle alternating current at 117 volts for the chief power requirements in the radio station. Without the power unit any commercial or other source of power having the same alternating current and voltage characteristics may be used to operate the radio station.

7. Main Components.—The main components of Radio Set SCR-399-(*) are divided between two vehicular units; the first consists of Shelter HO-17-(*) and other components installed on or within it, comprising the radio station; the second is the power plant and consists of Trailer K-52-E carrying the remaining components, the most important one being Power Unit PE-95-(*). The main components which form the radio station in the shelter should be considered as consisting of two groups; the first and more important of these (referred to as the “operating components”) is made up of the transmitting and receiving components which are at all times interconnected to function as a complete electrical system that ties in directly with the power unit; the second (referred to as the “accessory components”) consists of spare parts, tools, chests, and a few components occasionally used with the operating group. Thus, although an alphabetical list will be found in Paragraph 9., by vehicular units and functional families, the major components of Radio Set SCR-399-(*) may be listed here as follows:

a. The Radio Station.—Shelter HO-17-(*), in which are installed the following:

- (1) Operating Components.
 - (a) Antenna Tuning Unit BC-939-A.
 - (b) Radio Transmitter BC-610-E.
 - (c) Mast Base MP-47 (used for transmitting).
 - (d) Mast Sections MS-49, 50, 51, 52, 53, 54.
 - (e) Mast Base MP-48 (used for receiving).
 - (f) 2 Headsets HS-30-(*) with Cords CD-605.
 - (g) Chest CH-120-A, in which are mounted and interconnected:
 1. Speech Amplifier BC-614-E.
 2. Junction Box JB-70-A.
 3. Radio Receiver BC-342-(*).
 4. Loudspeaker LS-3.
 5. Key J-37.
 6. Microphone T-50-(*).

(h) Chest CH-121-A in which are mounted and interconnected:

1. Radio Receiver BC-312-(*).
 2. Loudspeaker LS-3.
 3. Key J-37.
 - (i) Chest CH-109-A with 12 V storage battery, and connecting cordage.
 - (j) Coils and tuning units for Radio Transmitter BC-610-E, stowed in Chest CH-88-A.
 - (2) Accessory Components.
 - (a) Frequency Meter Set SCR-211-(*).
 - (b) Equipment for Remote Control of Radio Set SCR-399-(*) or SCR-499-(*) consisting of:
 1. 2 Telephones EE-8-(*).
 2. Junction Box JB-60-A.
 3. Key J-45.
 4. 2 Reels DR-4 mounted on Frame FM-59-A.
 5. Approximately 1 mile of Wire W-110-B.
 6. Axle RL-27-B.
 - (c) Extension Cords.
 - (d) Chest CH-89-A (seat bench).
 - (e) Chest CH-88-A (wall).
 - (f) Chest CH-119-A (wall).
 - (g) Electric heater (117 volts, 1500 watts) mounted on floor.
 - (h) Microphone T-17.
 - (i) Microphone T-30-(*) (throat), stowed in Chest CH-88-A.
 - (j) 1 Portable typewriter, with telegraphic keyboard.
 - (k) 3 Straps ST-19-A, stowed in Chest CH-89-A.
 - (l) Rectifier RA-63-A.
 - (m) Spare parts contained in Chests CH-88-A and CH-89-A.
 - (n) Tools and repair equipment contained in Chest CH-89-A.
 - (o) Tool Equipment TE-48.
 - (p) Set of canvas covers for main components.
 - (q) Speaking tube.
 - (r) Ventilating fan.
- b. The Power Plant.**—Trailer K-52-E, 1 ton, 2 wheel, in which are installed:
- (1) Power Unit PE-95-(*) and Cord CO-316 normally terminating at the power plug near the rear of Shelter HO-17-(*).

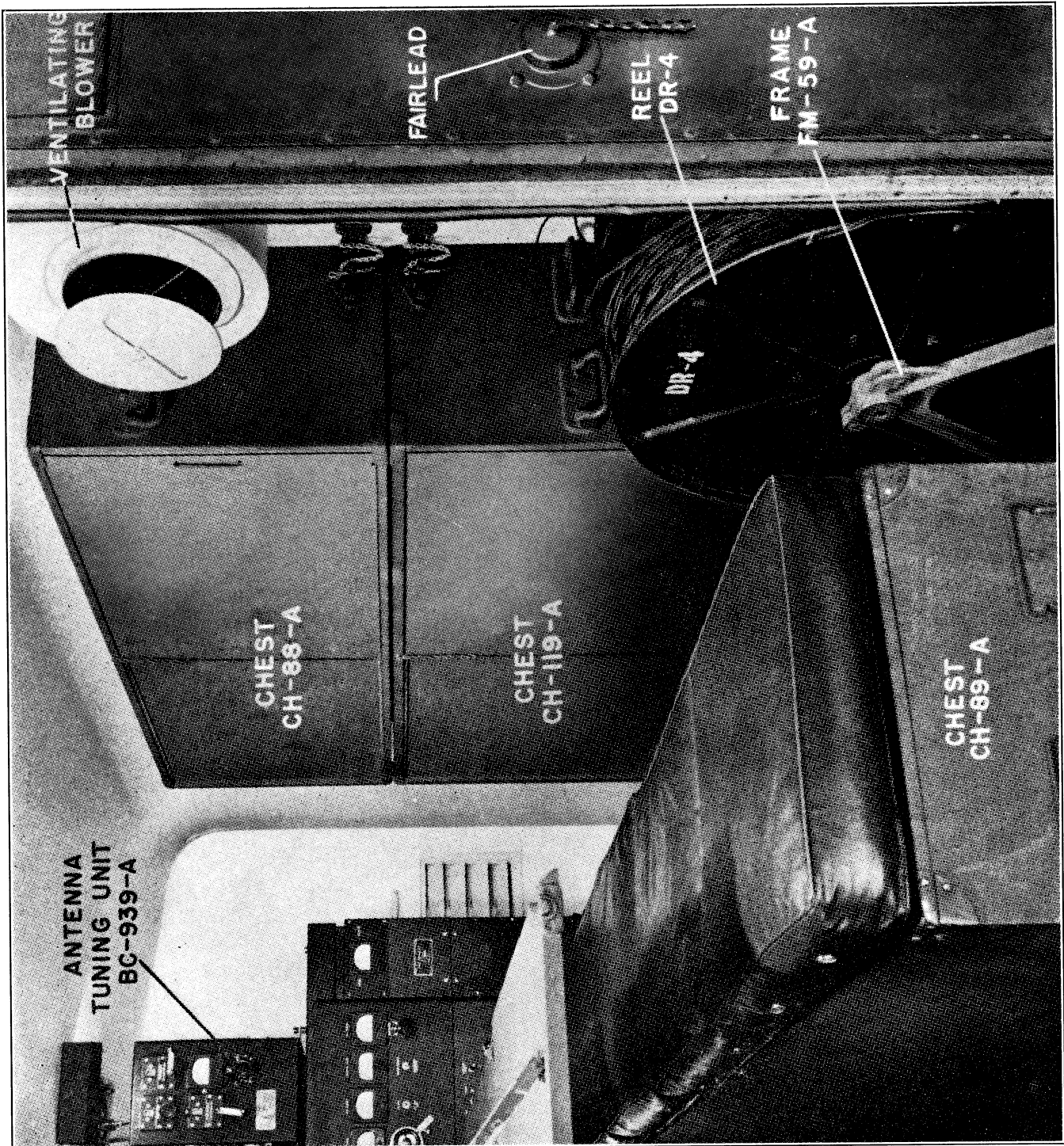

Figure 4—Radio Set SCR-399-A, inside view, showing accessory components

(2) Cord CO-313, a-c power, emergency, 100 ft., stored in Chest CH-112-A.

(3) 6 galvanized steel, 5 gallon, gasoline drums (QM Stock No. 42-D-1280).

(4) Spare wheel and tire for either truck or trailer, mounted in Frame FM-62-A.

8. Brief Description.

a. The Radio Station.

(1) Operating Components.—Among these, the principal transmitting components consist of Radio Transmitter BC-610-E with Antenna Tuning Unit BC-939-A, Speech Amplifier BC-614-E and Junction Box JB-70-A. Each of these units is explained in detail later in the text.

(a) Antenna Tuning Unit BC-939-A is mounted on top of and connected to Radio Transmitter BC-610-E to match the output of the transmitter to the 15 foot antenna. Weight 48 lbs.

Caution: When power is on, do not touch any leads to, or any part of, this unit except its front panel controls.

(b) Radio Transmitter BC-610-E is shock-mounted on the floor near the front of Shelter HO-17-(*), with its front panel controls facing the rear. This transmitter includes a shock-mounting base, plug-in tuning components and two sets of tuning charts.

1. The cradle frame shock-mounting base is bolted to the transmitter. The base is anchored to the floor with wrench nuts. Weight 51 lbs.

2. The plug-in tuning components consist of three sets of tuning units, 8 per set; two sets of coil units, 7 per set; Capacitor CA-423. (See Table of Tuning Components, Section V.)

3. The frequency range is 2 to 18 megacycles. Each tuning unit and associated coil unit or coil unit with capacitor covers a portion of the range. (See Table of Tuning Components, Section V.)

4. Frequency control is either by master oscillator or by crystal, and selection is made by switch on the tuning unit.

5. The transmitter power requirements are 1700 to 2000 watts, 117 volts, 50-60 cycles a-c.

6. Type of emission provided is continuous wave (c-w) telegraphy or amplitude modulation (voice).

7. Power output of transmitter exceeds 400 watts c-w and 300 watts voice, below 8 megacycles; and is slightly less at higher frequencies.

8. Weight, less shock-mount base: 401½ lbs.

(c) Speech Amplifier BC-614-E is located on top of Junction Box JB-70-A in Chest CH-120-A, where its shockproof base is securely mounted. It is held to its base by four snap fasteners. This speech amplifier is a companion unit to and should be considered as a part of Radio Transmitter BC-610-E. As its name implies, its chief function is to amplify the output of the microphone to a level suitable for input to the transmitter when voice modulation is desired. It also provides side-tone for headset monitoring of c-w transmissions. Speech Amplifier BC-614-E contains its own rectifier and operates on 117 volts 50-60 cycles a-c drawing approximately 40 watts. Its weight is 301½ lbs., less shock-mount.

(d) Junction Box JB-70-A serves both as a junction point for cords and cables which interconnect the various components and also as a control unit for the principal radio station functions. The various power connections together with the connections to the radio receivers plug into either the bottom (through the bottom of Chest CH-120-A) or the side of the junction box. Keys and headsets are plugged into the front. Front panel switches provide for starting or stopping Power Unit PE-95-(*), control of transmission or reception, selection of remote operating, turning on c-w side-tone, and choice of manual or automatic receiver disabling for protection of the receivers when receiving on or near the transmitter frequency or its harmonic. Weight, including cabinet, 37 lbs.

(e) Microphone T-50 is located in Chest CH-120-A where it should be slipped over a metal tongue mounting when not in use. It is a low level dynamic type, equipped with a press-to-talk switch which operates the transmitter. A cable and connector link it to Speech Amplifier BC-614-E.

(f) Mast Base MP-47 and five Mast Sections MS-49 to MS-53 inclusive form the transmitting antenna. The base is mounted through the roof of Shelter HO-17-(*), inside which a lead connects it to Antenna Tuning Unit BC-939-A. Mast Section MS-53 is screwed into the base forming the lowest section and MS-49 is at the end. In operating position this transmitting antenna is bent backwards to a horizontal position, being held down by an insulated guy to the rear of the roof. This provides clearance and keeps the antenna from whipping about while the vehicle is in motion. The snap-catches on the guy permit the release of the antenna to a vertical position

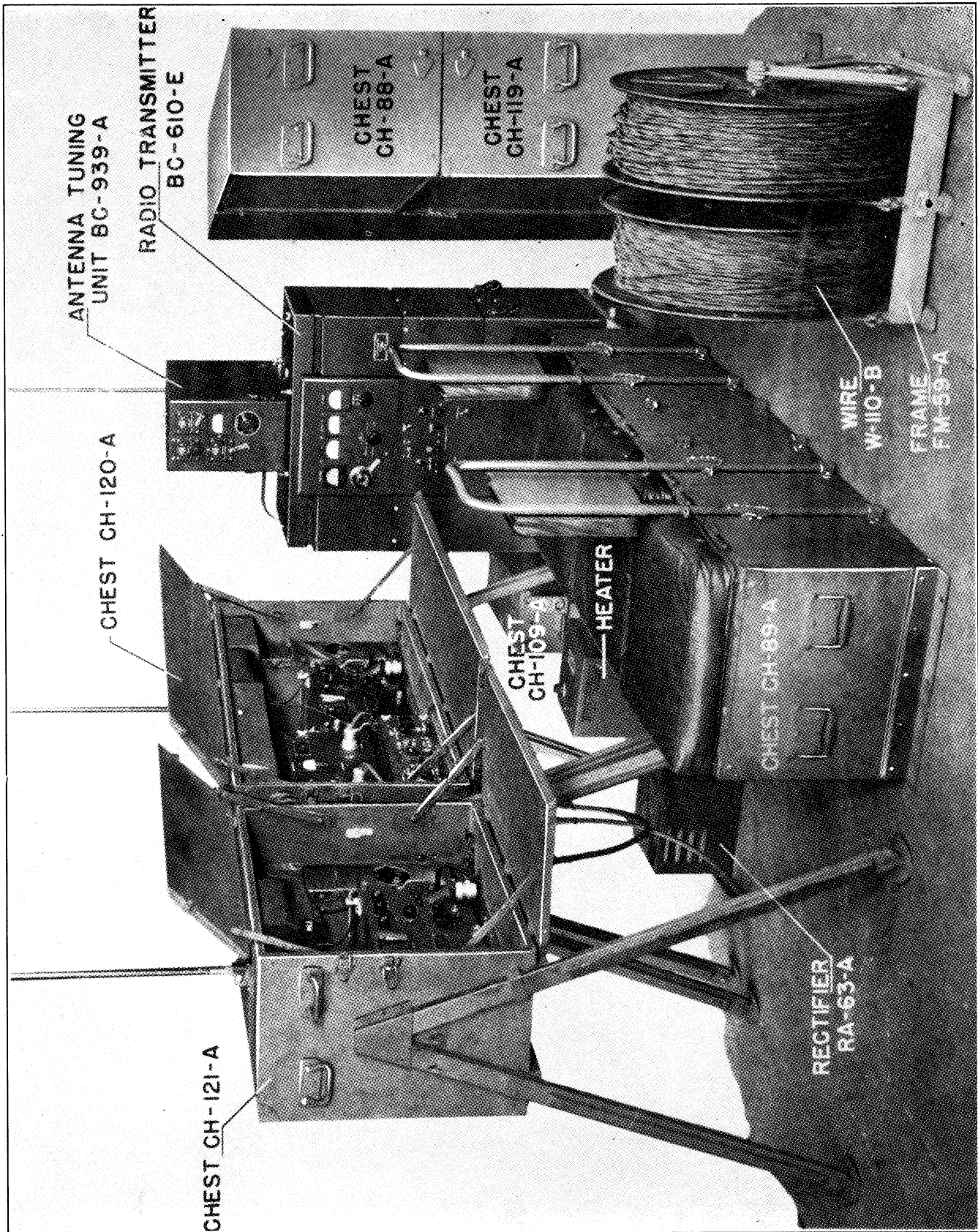

Figure 5—Radio Sets SCR-399-(*) and SCR-499-(*), operating components set up for field use

for transmitting when the set is stationary and greater radiation is required. Under this condition, one or two additional Mast Sections MS-54 may be added, if necessary, at the base.

Caution: Extremely high and dangerous voltages are present in the antenna and its insulator during transmissions. Do not touch.

(g) The principal receiving components consist of Radio Receivers BC-312-(*) and BC-342-(*) and the receiving antennae.

(h) Radio Receiver BC-312-(*) is mounted in Chest CH-121-A at the left (rear) operating position, including, for shock absorption, Mounting FT-162 and Mountings FT-178. This receiver is powered by 12 volts d-c supplied by the 12-volt battery in Chest CH-109-A. This receiver enables reception of c-w, voice or tone modulated signals over the frequency range 1.5 to 18 megacycles. Further description may be obtained from the Technical Manual TM 11-850 for Radio Receiver BC-312-(*) which is provided.

(i) Radio Receiver BC-342-(*) is mounted in Chest CH-120-A at the right (forward) position, including, for shock absorption, Mounting FT-162 and Mountings FT-178. It has the same characteristics as Radio Receiver BC-312-(*) except that it operates from 117 volts 50-60 cycle a-c power. Consult Technical Manual TM 11-850 for Radio Receiver BC-342-(*) for further description.

(j) Mast Bases MP-48 are mounted on Mast Base Brackets MP-50-A, which are fastened to the rear of Shelter HO-17-(*)).

(k) Chest CH-120-A (main operating) is mounted on a frame against the left side of Shelter HO-17-(*). It is held in place by a combination of cleats and turn buckles. All of the necessary radio components for one operating position except Radio Transmitter BC-610-E are mounted in this chest. Junction Box JB-70-A and Speech Amplifier BC-614-E control transmission and change-over from transmission to reception, while Radio Receiver BC-342-(*) with Loudspeaker LS-3 provides reception. The layout and identification of the components mounted in position are shown in Figure 9. A lamp fixture provides light for the operator, and compartments are provided for storage of headsets, microphones, technical manuals, message blanks, field telephone, spare fuses, and other accessories. Box BX-19-A mounted in the chest contains spare fuses, tubes, and lamps for the receiver. The lower front cover of Chest CH-120-A opens to form an operating desk on which can be mounted

a portable typewriter. A set of field legs strapped to this chest is for use when the chest is set up outside the shelter.

(l) Chest CH-121-A (auxiliary operating) is mounted adjacent to Chest CH-120-A and provides a second operating position. Included are Radio Receiver BC-312-(*) with Loudspeaker LS-3, and compartments for storage of headsets, spare battery cord, field telephone, remote control equipment, and other accessories. Also mounted in this chest are a lamp fixture and Box BX-19-A, including spare tubes, fuses, lamps, and dynamotor brushes for the receiver. The lower front cover opens, forming a desk as in Chest CH-120-A, and sockets for legs are provided.

(m) Cordage used in operating the radio stations is listed and described as follows:

1. Cord CD-566 (control) is the 4-foot control cord connecting Radio Receiver BC-342-(*) with its outlet receptacle in Junction Box JB-70-A.

2. Cord CD-564 (power) is a 3-foot power cord connecting Radio Receiver BC-342-(*) with the a-c receptacle in Junction Box JB-70-A.

3. Cord CD-565 (control, power) is the 4-foot power and control cord connecting Radio Receiver BC-312-(*) with its receptacle in the junction box.

4. Cord CD-763 (transmitter power) is 14 feet long and connects Radio Transmitter BC-610-E with its a-c power receptacle in the junction box.

5. Cord CD-764 (transmitter control) is 15 feet in length. It conducts speech and control circuits to Radio Transmitter BC-610-E and furnishes Speech Amplifier BC-614-E with a-c power. One end plugs into the rear of the transmitter; the other end plugs into the front of the speech amplifier chassis.

6. Cord CO-335 (power and control) is 14 feet in length and is used to carry the power and control circuits from Junction Box JB-70-A to the rear of the shelter for connection to Power Unit PE-95-(*). It is provided at one end with a heavy duty cable plug, which is clamped underneath the rear of the truck, and at the other end with another heavy duty plug for making connection to the junction box.

(n) The 12-volt battery located in Shelter HO-17-(*) near the escape door consists of two 6-volt storage batteries connected in series. They are interchangeable with the batteries in Power

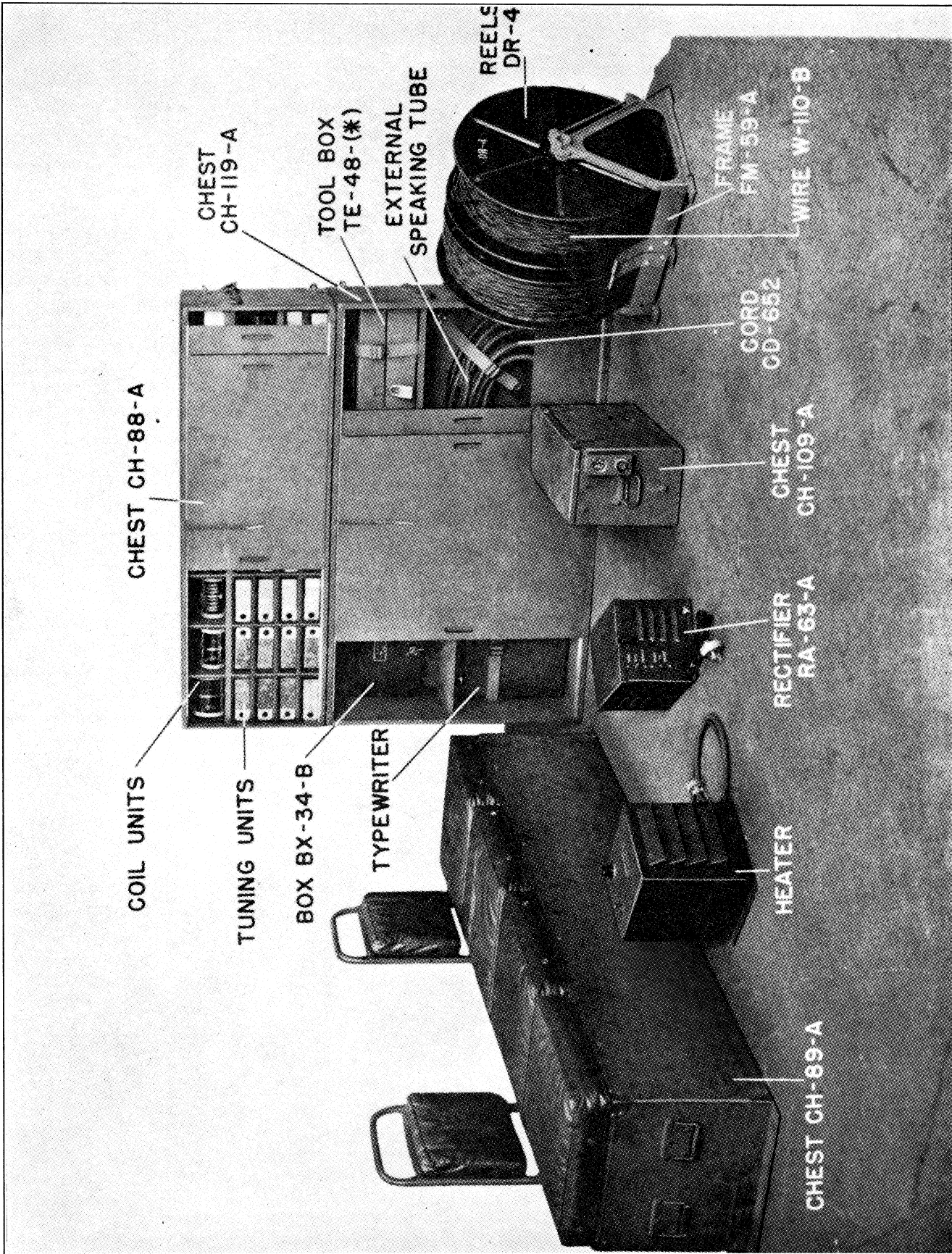

Figure 6—Radio Sets SCR-399-(*) and SCR-499-(*), accessory components

Unit PE-95-(*). The battery is wired to a polarized plug mounted on the outside of Chest CH-109-A.

(o) Radio Set SCR-399-(*) or SCR-499-(*) includes two sets of Crystal Holders FT-171-B whose crystals have the following author-

ized operating frequencies: (For convenience, a third column is included to show the additional operating frequencies which may be obtained by use of different tuning units. Two groups of frequencies are shown, only one of which is supplied with a given set.)

GROUP 1					GROUP 2				
Crystal Frequency	Authorized Operating Frequency	Use Tuning Unit	Additional Possibilities in Operating Freq.	Use Tuning Unit	Crystal Frequency	Authorized Operating Frequency	Use Tuning Unit	Additional Possibilities in Operating Freq.	Use Tuning Unit
2030	2030	TU-47	4060	TU-50	2030	2030	TU-47	4060	TU-50
2220	2220	TU-47	4440	TU-50	2052.5	2052.5	TU-47	4105	TU-50
2258	2258	TU-47	4516	TU-50	2085	2085	TU-47	4170	TU-50
2300	2300	TU-47	4600	TU-50	2117.5	2117.5	TU-47	4235	TU-50
2360	2360	TU-47	4720	TU-50	2160	2160	TU-47	4320	TU-50
2390	2390	TU-47	4780	TU-50	2200	2200	TU-47	4400	TU-50
3510	3510	TU-49	7020	TU-52	2217.5	2217.5	TU-47	4435	TU-50
3520	3520	TU-49	7040	TU-52	2390	2390	TU-47	4780	TU-50
3550	3550	TU-49	7100	TU-52	2415	2415	TU-47	4830	TU-50
3570	3570	TU-49	7140	TU-52	2436	2436	TU-47	4872	TU-50
3580	3580	TU-49	7160	TU-52	2532.5	2532.5	TU-48	5065	TU-51
3945	3945	TU-49	7890	TU-52	2647.5	2647.5	TU-48	5295	TU-51
3955	3955	TU-49	7910	TU-52	2772	2772	TU-48	5544	TU-51
3995	3995	TU-49	7990	TU-52	2980	2980	TU-48	5960	TU-51
2045	4090	TU-50	2045	TU-47	3000	3000	TU-48	6000	TU-51
2065	4130	TU-50	2065	TU-47	3035	3035	TU-48	6070	TU-51
2105	4210	TU-50	2105	TU-47	3100	3100	TU-48	6200	TU-51
2125	4250	TU-50	2125	TU-47	3120	3120	TU-48	6240	TU-51
2145	4290	TU-50	2145	TU-47	3150	3150	TU-48	6300	TU-51
2155	4310	TU-50	2155	TU-47	3155	3155	TU-48	6310	TU-51
2260	4520	TU-50	2260	TU-47	3232.5	3232.5	TU-49	6465	TU-52
2282.5	4565	TU-50	2282.5	TU-47	3265	3265	TU-49	6530	TU-52
2290	4580	TU-50	2290	TU-47	3322.5	3322.5	TU-49	6645	TU-52
2305	4610	TU-50	2305	TU-47	3417.5	3417.5	TU-49	6835	TU-52
2320	4640	TU-50	2320	TU-47	3475	3475	TU-49	6950	TU-52
2415	4830	TU-50	2415	TU-47	3585	3585	TU-49	7170	TU-52
2435	4870	TU-50	2435	TU-47	3665	3665	TU-49	7330	TU-52
2442.5	4885	TU-50	2442.5	TU-47	3725	3725	TU-49	7450	TU-52
2532.5	5065	TU-51	2532.5	TU-48	3785	3785	TU-49	7570	TU-52
2545	5090	TU-51	2545	TU-48	3792.5	3792.5	TU-49	7585	TU-52
2557.5	5115	TU-51	2557.5	TU-48	3850	3850	TU-49	7700	TU-52
3202.5	6405	TU-52	3202.5	TU-49	3865	3865	TU-49	7730	TU-52
3215	6430	TU-52	3215	TU-49	3905	3905	TU-49	7810	TU-52
3237.5	6475	TU-52	3237.5	TU-49	3935	3935	TU-49	7870	TU-52
3250	6500	TU-52	3250	TU-49	3995	3995	TU-49	7990	TU-52
3322.5	6645	TU-52	3322.5	TU-49	3997.5	3997.5	TU-49	7995	TU-52

NOTE—Although no crystals are included for frequencies above 8 mc., the following examples show typical crystal and operating frequencies in this range.

Crystal Frequency	Operating Frequency	Tuning Unit
4500	9,000	TU-53
5500	11,000	TU-53
3500	14,000	TU-54
4500	18,000	TU-54

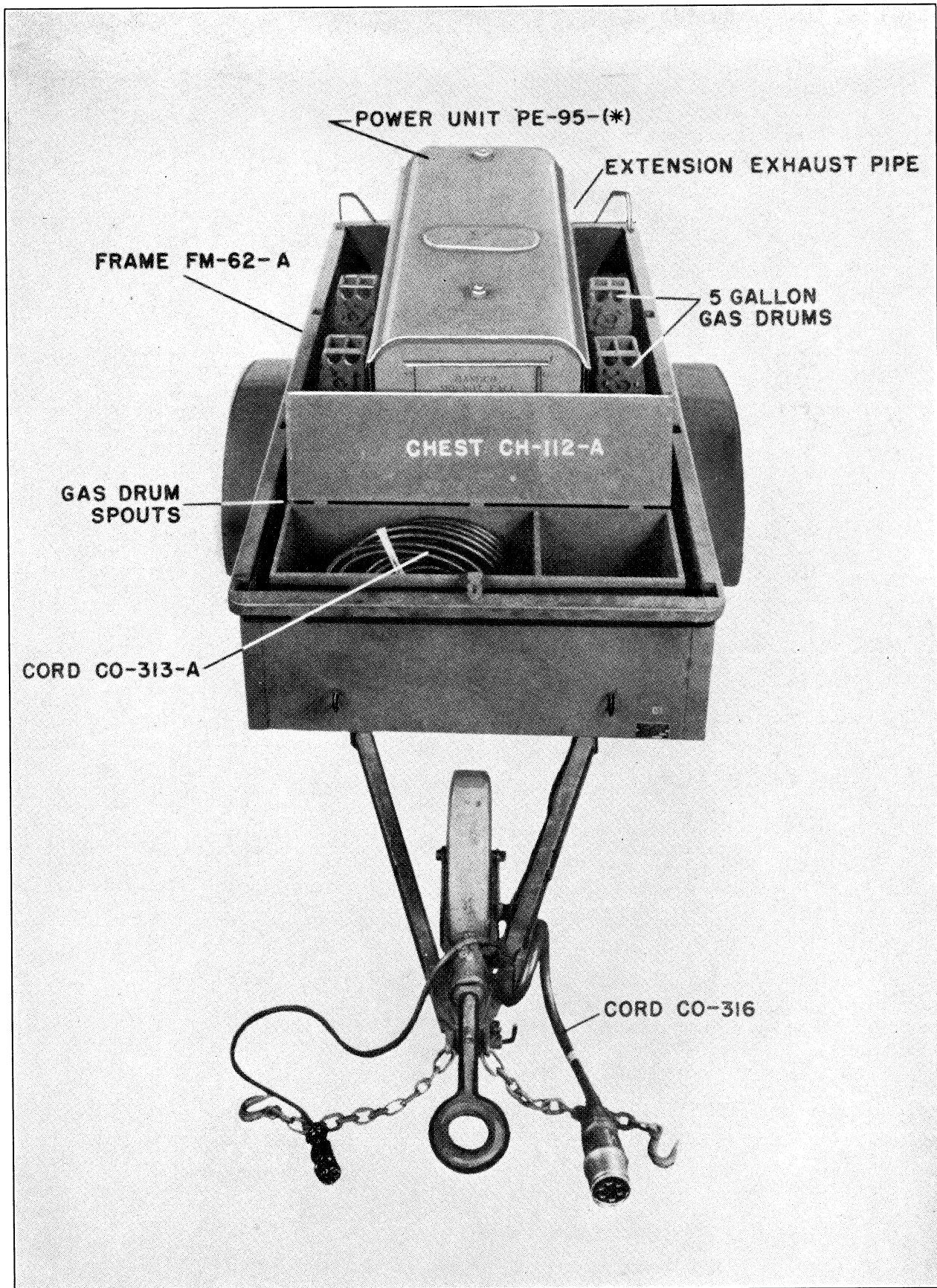

Figure 7—Trailer K-52-E (power equipment) with covers removed

(2) Accessory Components.

(a) Frequency Meter Set SCR-211-(*) is located in Chest CH-119-A where it is held in place with a strap. It can be used for presetting Radio Transmitter BC-610-E to any exact frequency for net operation and other requirements. Its separate technical manual found within the set describes its operation in detail.

(b) Equipment for remote control consists of:

1. Telephone EE-8-(*) (two) one located in Chest CH-120-A and one in Chest CH-121-A.
2. Junction Box JB-60-A, stowed in Chest CH-121-A.
3. Key J-45, stowed in Chest CH-121-A.
4. Reels DR-4 (two) mounted in Frame FM-59-A.
5. Wire W-110-B, approximately $\frac{1}{2}$ mile on each reel.
6. Axle RL-27-B stowed in Chest CH-89-A.

(c) This remote control equipment when connected as directed in Section II provides for:

1. Remote keying or voice modulating Radio Transmitter BC-610-E.
2. Remote listening to Radio Receiver BC-312-(*) or BC-342-(*).
3. Communicating with the operator in the radio station.

The remote position may be located as much as one mile distant. Note that when both remotely receiving and transmitting or when remotely voice modulating, it is necessary to have an operator at the radio station to switch the remotely located Telephone EE-8-(*) from transmit to receive or to turn off the carrier when so directed from the remote position. Remote keying of c-w transmissions may be effected without the assistance of the station operator; and reception at the remote point may then be obtained by placing Radio Receiver BC-312-(*) and the 12-volt battery at the remote point.

(d) Equipment for operation of Power Unit PE-95-(*) at a distance up to 200 feet from Shelter HO-17-(*) and for individual operation of station and trailer consists of three cords as follows:

1. Cord CD-652 (power and control), for extending all connections, between shelter and trailer. Its length is 100 feet and it is provided at the ends with plugs for connecting to the power

plug at the rear of the shelter and the power plug at the tongue of the trailer.

2. Cord CO-313 (a-c power) for extending the a-c power connection from the trailer. Its length is 100 feet. One end is provided with a plug which fits the power plug at the tongue of the trailer and the other end has two terminals from which power may be taken for any desired purpose.

3. Cord CO-314 (a-c power), for connecting other sources of a-c power to Shelter HO-17-(*) for operation of the radio station. Length: 3 feet. It has a plug at one end for attachment to the power plug at the rear of the shelter. The other end has bare leads for connection to any source of commercial power.

(e) Chest CH-89-A (seat bench) is mounted by means of wing bolts to the floor of Shelter HO-17-(*), and is situated parallel with the operating chests. Its dimensions are 6' 8" long, 14 $\frac{1}{2}$ " high (not including cushions) and 18" wide. Fully packed the chest weighs approximately 275 lbs. Its top is divided into four lids. Each is equipped with a cushion to serve when closed as a seat for the operators. Below each lid is a large compartment subdivided for stowage of spare parts, repair equipment, etc., as indicated on the chart attached to the chest. Two removable back rests, together with Straps ST-19-A hooked to the Chest CH-89-A, secure the operator in place when driving on rough roads.

(f) Chest CH-119-A is mounted inside and along the right-hand wall of Shelter HO-17-(*). It is held in place to the side of the shelter by four trunk clasps. Its dimensions are 55" long, 32 $\frac{1}{2}$ " high, and 12 $\frac{5}{8}$ " deep. Its weight fully packed is approximately 287 lbs. Two sliding doors on its front side permit access to the interior compartments in which are stowed the frequency meter, the portable typewriter, the box of crystals, Cord CD-652, and Tool Equipment TE-48. Some additional storage space is available for storage of other material.

(g) Chest CH-88-A (wall) is mounted inside and along the right wall on top of Chest CH-119-A. It is held to the side of the shelter by four trunk clasps. Its dimensions are 55" long, 18" high, and 12 $\frac{5}{8}$ " deep; its weight, fully packed, is approximately 163 lbs. Two sliding doors on its front side permit access to the many compartments within, where tuning units and other items are stowed in accordance with the chart provided.

(h) Cord CD-659 (the 12 V battery cord) is 6 feet long and connects between the outlet

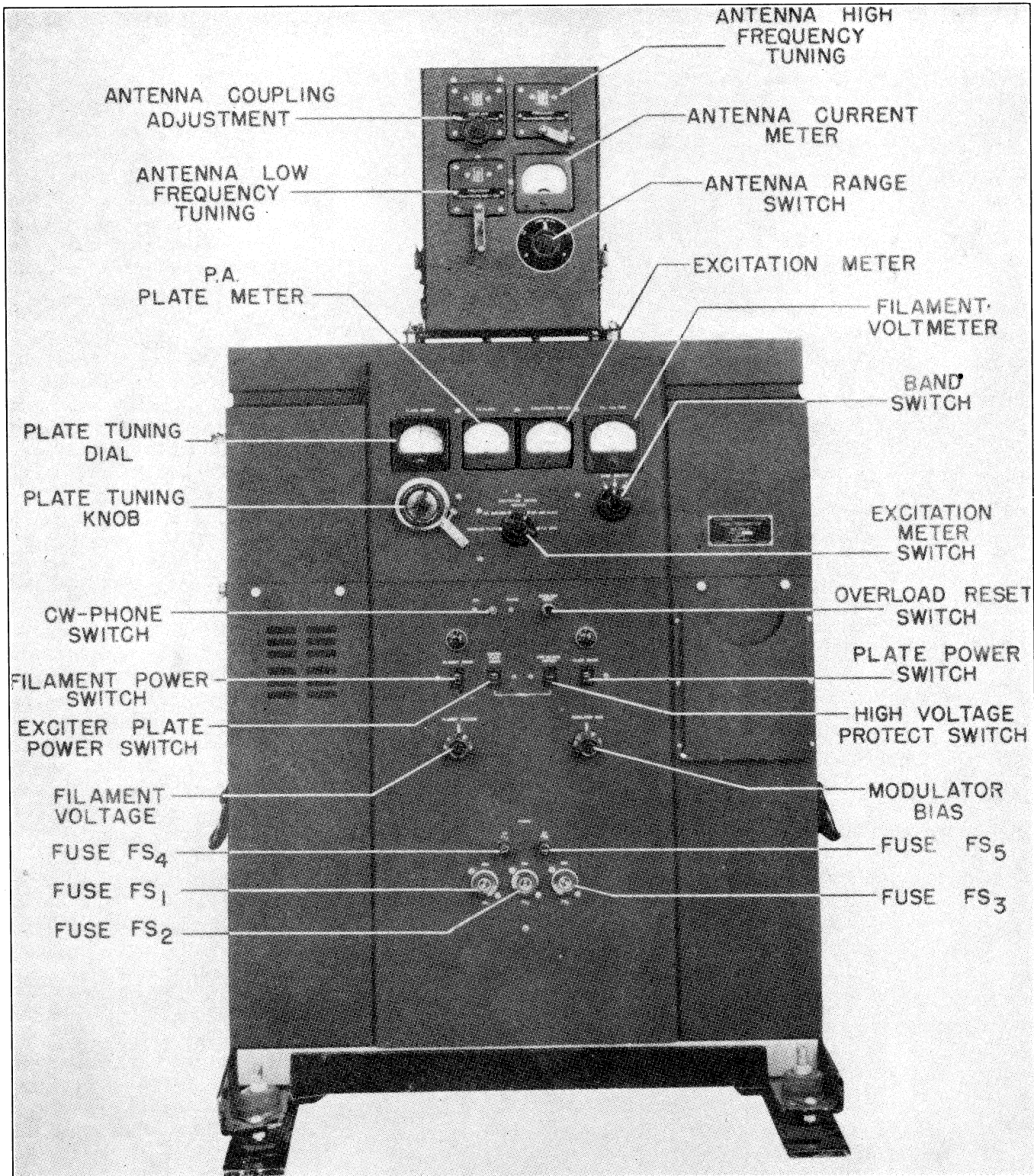

Figure 8—Radio Transmitter BC-610-E, with Antenna Tuning Unit BC-939-A, front view

receptacle on Junction Box JB-70-A and the plug outlet on Chest CH-109-A.

(i) Cord CD-690 (power) is 6 feet long and is used to connect Radio Receiver BC-312-(*) to the storage battery when both of these units are removed from the radio station.

b. The Power Plant.—Trailer K-52-E is a 1-ton, two-wheel vehicle to which has been added Frame FM-62-A (for spare tire and wheel) located beneath and accessible from its rear end. Six galvanized steel drums for gasoline and water have been installed, and Power Unit PE-95-(*) and its associated cords have been mounted in this trailer. Chest CH-112-A is mounted at the front for storage of Cord CO-313 and spare tools, etc. The operating components in the trailer are listed in the next column:

(1) Power Unit PE-95-(*) as supplied with this set is a gasoline-driven generating unit capable of delivering 5 kilowatts a-c power, single phase, 60 cycle at 117 volts. Tools and spare parts accompany the power unit. Its use has been described on previous pages. For further details and operating data for this unit, its technical manual should be consulted.

(2) Cord CO-316 (power and control) is a 6-conductor cord, 11.0 feet long, which at one end connects to the terminal board of the power unit and at the other end connects to the power plug under the rear of the truck.

9. Alphabetical Tabulation of Components.

The following is a complete list of components included in Radio Sets SCR-399-(*) and SCR-499-(*).

Quan.		Article	Quan.		Article
SCR-399-(*)	SCR-499-(*)		SCR-399-(*)	SCR-499-(*)	
4	4	Antenna Guy Assembly (receiver)	1	1	Chest CH-120-A (main operating)
2	2	Antenna Guy Assembly (transmitter)	1	1	Chest CH-121-A (auxiliary)
1	1	Antenna Tuning Unit BC-939-A	1	1	Cord CD-318-A for Microphone T-30-(*)
1	1	Axle RL-27-B	1	1	Cord CO-335 (power and control) length 14 ft.
12	12	Battery BA-30, spare	4	4	Cord CD-605
2	2	Battery, storage, 6 volt	1	1	Cord CD-652 (power and control extension), length 100 ft.
2	2	Book, Instruction, or Technical Manual for Power Unit PE-95-(*)	1	1	Cord CO-316 (power and control), length 11.0 ft.
2	2	Book, Instruction, or Technical Manual for Radio Receivers BC-312-(*) and BC-342-(*)	1	1	Cord CO-313 (a-c extension), length 100 ft.
2	2	Book, Instruction, or Technical Manual for Frequency Meter Set SCR-211-(*)	1	1	Cord CO-314 (a-c connection), length 3 ft.
2	2	Book, Instruction, or Technical Manual for Telephone EE-8-(*)	1	1	Cord CD-690 (power), 12-volt battery, receiver, 6 ft.
2	2	Box BX-19-A	2	2	Cord CD-564 (power), 3 ft.; 1 in use, 1 spare
1	1	Box, BX-34-B with crystals	2	2	Cord CD-565 (control, power), 4 ft.; 1 in use, 1 spare
6		Bracket for gasoline can	2	2	Cord CD-566 (control), 4 ft.; 1 in use, 1 spare
2	2	Brush, HV, for dynamotor of BC-312-(*), spare	2	2	Cord CD-763 (transmitter power), 14 ft.; 1 in use, 1 spare
2	2	Brush, LV, for dynamotor of BC-312-(*), spare	2	2	Cord CD-764 (transmitter control), 15 ft.; 1 in use, 1 spare
1	1	Bumper Clamp (for Cord CO-335)	1	1	Cord CD-659 (12-volt battery), 6 ft.
1	1	Chest CH-88-A (wall)	1	1	Counterpoise CP-15-B
1	1	Chest CH-89-A (seat bench)			
1	1	Chest CH-109-A (12-volt battery)			
1	1	Chest CH-112-A			
1	1	Chest CH-119-A (wall)			

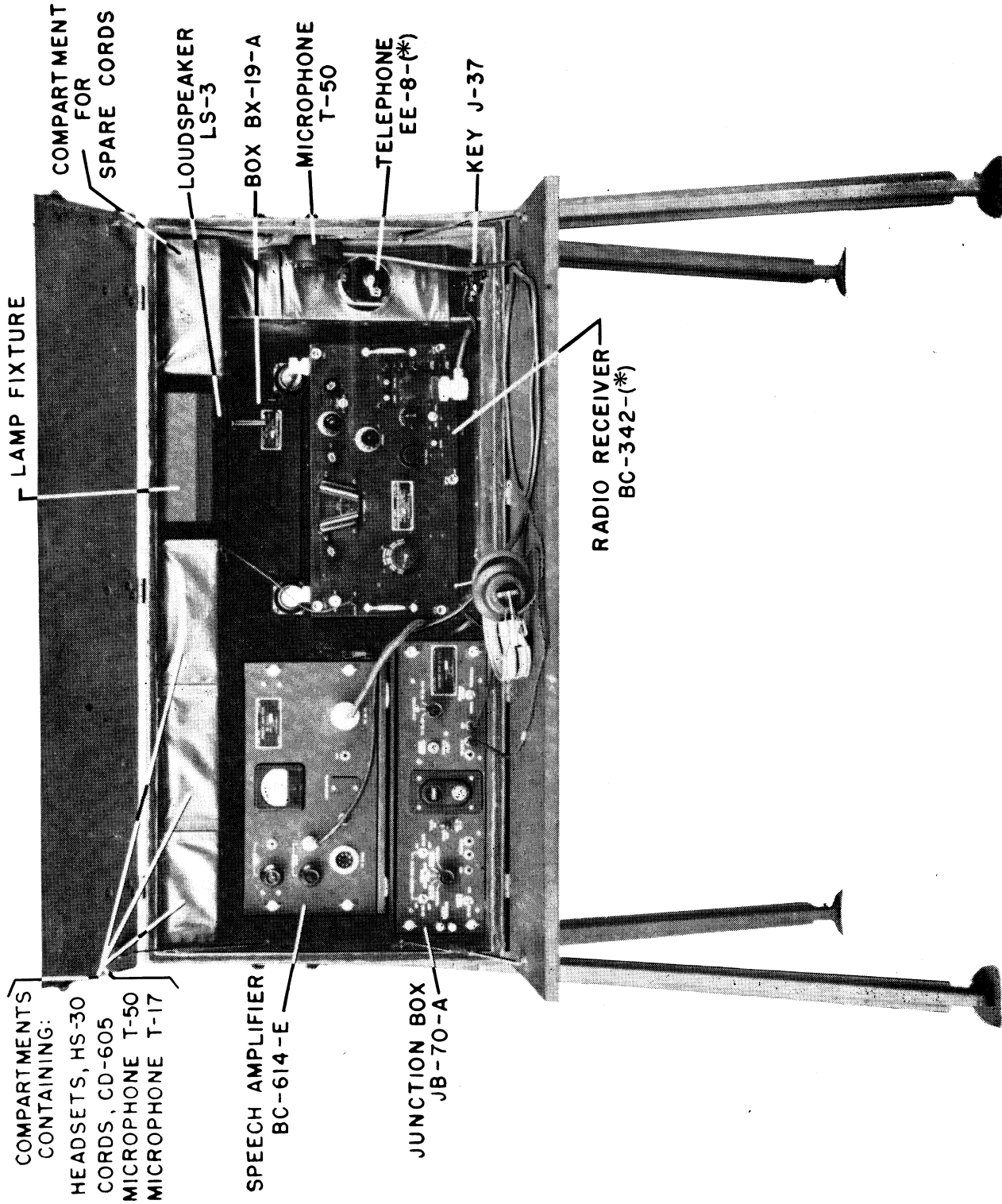

Figure 9—Chest CH-120-A (main operating), front view, with legs

Quan.		Article	Quan.		Article
SCR-399-(*)	SCR-499-(*)		SCR-399-(*)	SCR-499-(*)	
1	1	Cover BG-141-A (for Chest CH-89-A)	1	1	Lamp, trouble, emergency 12 V d-c with 25 ft. extension cord and 50 watt lamp
1	1	Cover BG-142-A (for Chest CH-119-A)	4	4	Lamp LM-27 for radio receivers; spare
1	1	Cover BG-143-A (for Chest CH-121-A)	2		(Sets) Lamps, for K-52-E; spare
1	1	Cover BG-144-A (for Chest CH-88-A)	1	1	Lamp fixtures (shelter)
1	1	Cover BG-145-A (for Chest CH-120-A)	2	2	Lamp fixture (operating chests)
1	1	Cover BG-146-A (for Radio Transmitter BC-610-E and Antenna Tuning Unit BC-939-A)	2	2	Loudspeaker LS-3
2	2	Sets Crystals in Crystal Holders FT-171-B	2	2	Mast Base MP-47; 1 in use, 1 spare
6		Drums, steel galvanized, gasoline with handle, 5 gallons	3	3	Mast Base MP-48; 2 in use, 1 spare
1	1	Frame FM-59-A (for Reels DR-4)	1	1	Mast Base Bracket MP-59-A (for Mast Base MP-47)
1		Frame FM-62-A (for spare tire)	3	3	Mast Base Bracket MP-50-A (for Mast Base MP-48)
1	1	Frequency Meter Set SCR-211-(* with spare tubes and batteries)	6	6	Mast Section MS-49; 1 in use, 5 spare
1	1	Fire extinguisher, Randolph Laboratories, Model FF-4	6	6	Mast Section MS-50; 1 in use, 5 spare
6	6	Fuse FU-21-A, for Radio Receivers BC-312-(* and BC-342-(*); spare	6	6	Mast Sections MS-51; 3 in use, 3 spare
4	4	Fuse FU-27, for Radio Receiver BC-342-(*); spare	6	6	Mast Section MS-52; 3 in use, 3 spare
7	7	Sets Fuses for Radio Transmitter BC-610-E and Speech Amplifier BC-614-E; 1 in use, 6 spare, consisting of: 2-25 Ampere 1-5 Ampere 1-20 Ampere 1-3 Ampere	6	6	Mast Section MS-53; 3 in use, 3 spare
1	1	Heater, electric, Electromode Model AA-15	2	2	Mast Section MS-54
4	4	Headset HS-30-(*); 2 in use, 2 spare	2	2	Microphone T-50 dynamic, 1 in use, 1 spare
1	1	Holder, for fire extinguisher	1	1	Microphone T-17
1	1	Junction Box JB-60-A	1	1	Microphone T-30-(*), (throat)
1	1	Junction Box JB-70-A	3	3	Nozzles for gasoline drums
3	3	Key J-37; 2 in use, 1 spare	1 set	1 set	Parts, spare, for Radio Transmitter BC-610-E and Speech Amplifier BC-614-E consisting of: 33% but not less than one each of the following component parts used in the radio transmitter and speech amplifier: Fixed and variable resistors Fixed capacitors Radio frequency choke coils 1 each type relay as used in Speech Amplifier BC-614-(* and Radio Transmitter BC-610-(*). 1 each every type switch used, other than band switch 4 each ceramic insulator used for plate-tank variable capacitor.
1	1	Key J-45			
7	7	Lamps, 50 watt, 115 volt, 3 in use, 4 spare			
3	3	Lamps, 50 watt, 12 V d-c; 1 in use, 2 spare			
2	2	Lamps, trouble, emergency, 117 volt with 25 ft. extension cord and 50 watt lamps			

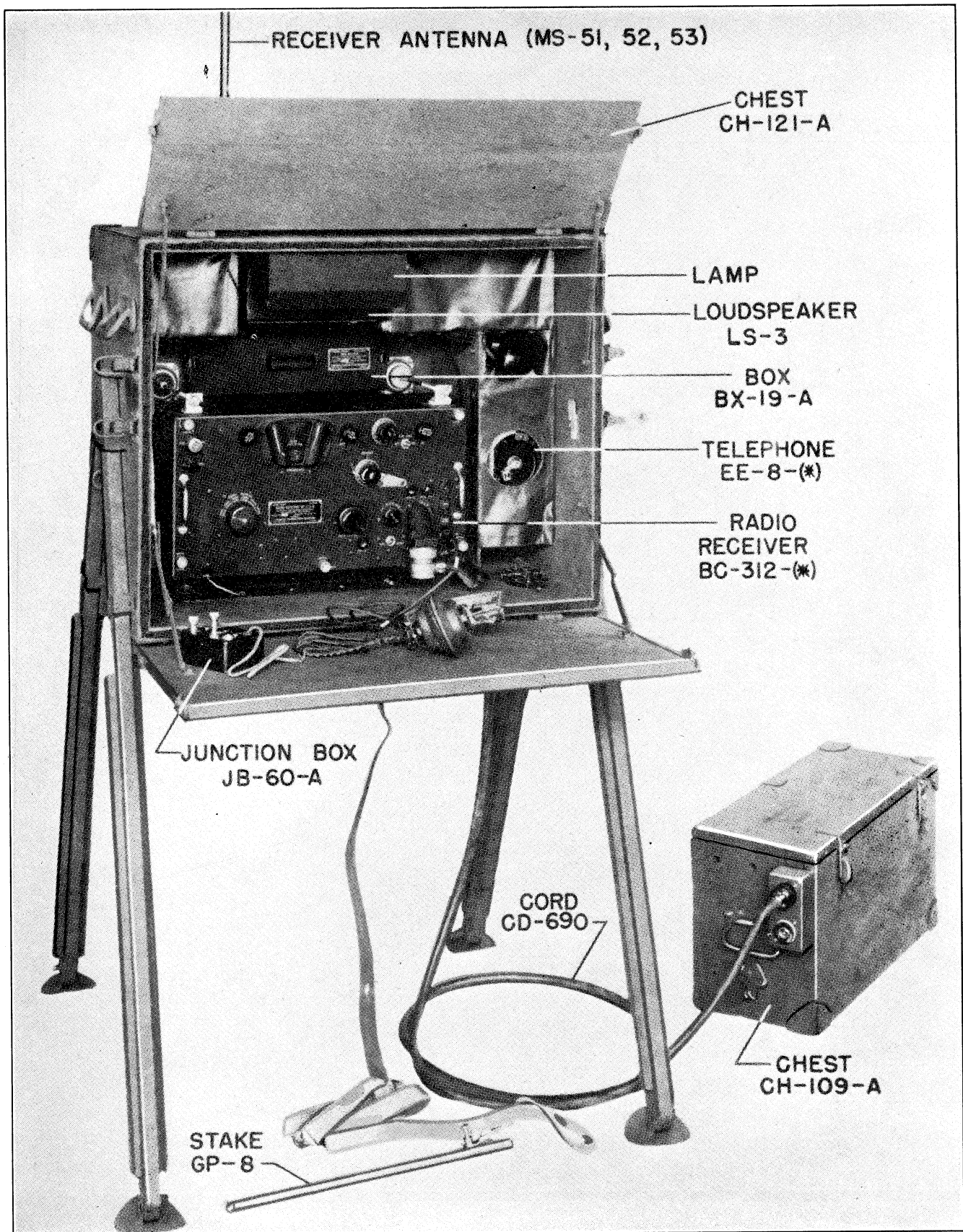

Figure 10—Chest CH-121-A (Auxiliary operating), with Chest CH-109-A, for field operation

Quan. SCR- 399-(*)	SCR- 499-(*)	Article	Quan. SCR- 399-(*)	SCR- 499-(*)	Article
		4 each ceramic insulator used for final amplifier coil unit.			1 Hammer, claw, 16 oz.
		1 each circuit breaker for Junction Box JB-70-A.			1 set Hardware, assorted
		6 each every Pilot Lamp and Dial Lamp used in Radio Transmitter BC-610-(*), and Speech Amplifier BC-614-(*). (For itemization of resistors, capacitors, and chokes supplied as spares, see Table of Replaceable Parts, Section V.)			1 Hydrometer for storage batteries
1	1	Power Unit PE-95-(*), includes tools and spare parts			5 lbs. Solder, rosin core
1	1	Radio Receiver BC-312-(*), includes Mounting FT-162 and 2 Mountings FT-178	8	8	1 can Machine Oil
1	1	Radio Receiver BC-342-(*), includes Mounting FT-162 and 2 Mountings FT-178	4	4	1 Soldering Iron TL-120
1	1	Radio Transmitter BC-610-E, includes 24 tuning units, 14 coil units, 2 capacitors CA-423, and 2 sets tuning charts	16	16	3 rolls Tape, friction, 1/2" rolls
1	1	Rectifier RA-63-A	4	4	1 roll Tape, rubber, 1/2" roll
2	2	Reels DR-4			1 Torch TL-130
50 ft.	50 ft.	Rope RP-5			2 No. 6-32 Allen Head Wrench
1	1	Speech Amplifier BC-614-E			2 No. 8-32 Allen Head Wrench
1		Shelter HO-17-(*), (mobile)			2 No. 10-32 Allen Head Wrench
1		Speaking tube			1 sheet Crocus Cloth
2	2	Stake GP-8, including 10 ft. copper braid			8 Tube VT-65-A for Radio Receivers BC-312-(*), and BC-342-(*); 4 installed, 4 spare
3	3	Strap ST-19-A			4 Tube VT-66-A for Radio Receivers BC-312-(*), and BC-342-(*); 2 installed, 2 spare
1		Table frame (for mounting Chests CH-120-A and CH-121-A in shelter)			16 Tube VT-86-A for Radio Receivers BC-312-(*), and BC-342-(*); 8 installed, 8 spare
2	2	Technical Manual TM 11-281 for Radio Sets SCR-399-A and SCR-499-A			4 Tube VT-87-A for Radio Receivers BC-312-(*), and BC-342-(*); 2 installed, 2 spare
2	2	Telephone EE-8-(*)			4 Tube VT-88-A for Radio Receivers BC-312-(*), and BC-342-(*); 2 installed, 2 spare
1		Tire and wheel, spare, for Trailer K-52-E and truck			2 Tube VT-97 for Radio Receiver BC-342-(*); 1 installed, 1 spare
1	1	Tool Equipment TE-48			2 Sets Tubes, vacuum, for Radio Transmitter BC-610-E; 1 set installed, 1 set spare; consisting of:
1	1	Set tools and repair equipment consisting of:			2 Tube VT-46-A
		1 Analyzer BC-1052-E			3 Tube VT-139
		1 Can Carbon Tetrachloride			2 Tube VT-95
		1 Drill, electric, 110 V., 1/2"			2 Tube VT-145
		1 Drill, twist, carbon steel, 3/8"			2 Tube VT-100
		1 Drill, twist, carbon steel, 1/2"			2 Tube VT-218
		2 pair Pliers			1 Tube VT-107
					1 Tube VT-220
					1 Tube VT-115
					2 Sets tubes, vacuum, for Speech Amplifier BC-614-E; 1 set installed, 1 set spare, consisting of:
					1 Tube VT-80
					2 Tube VT-94
					1 Tube VT-103
					3 Tube VT-231
					1 Tube VT-233
					1 Typewriter, portable, with telegraphers keyboard, includes case
					Trailer K-52-E
					100 ft. } Wire, Antenna
					100 ft. }
					4800 ft. } Wire W-110-B (on Reels DR-4)
					4800 ft. }

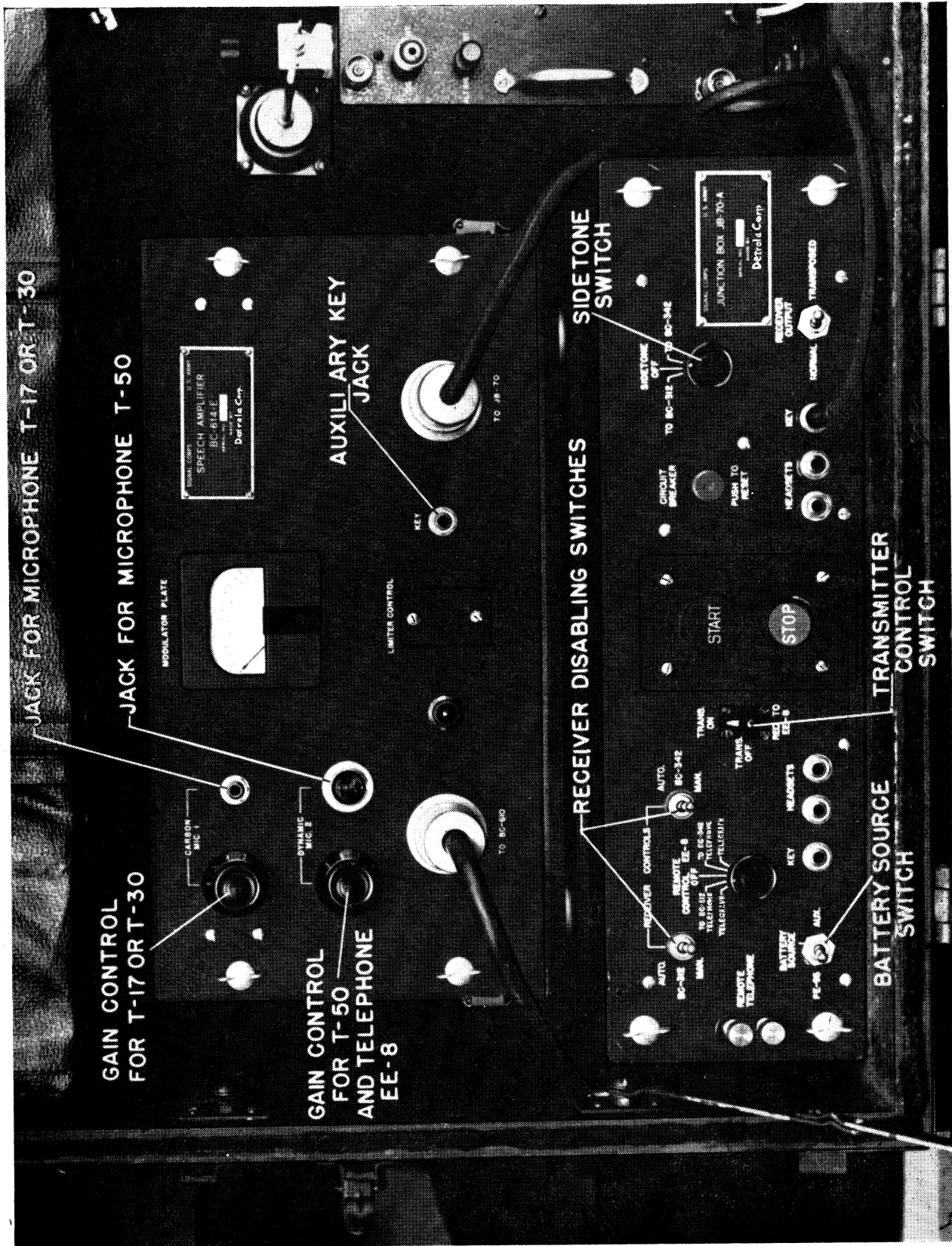

Figure 11—Speech Amplifier BC-614-E, and Junction Box JB-70-A, front view

SECTION II—INSTALLATION AND OPERATION

	<i>Paragraph</i>
Installation of Radio Set SCR-399-(*) In Shelter HO-17-(*)	10
Installation of Radio Set SCR-499-(*) for Field Operation	11
Preparation for Use of Radio Set SCR-399-(*)	12
Preparation for Use of Radio Set SCR-499-(*)	13
Precautions Before Operating	14
Transmitting	15
Reception	16
Battery System	17

10. Installation [SCR 399-(*)].

a. If Radio Set SCR-399-(*) is delivered with Shelter HO-17-(*) mounted on a cargo vehicle to which is coupled Trailer K-52-E, it should be considered completely installed. Certain seals, wrapping, braces, tapes, and other packing may have been added for protection during shipment. Remove these before proceeding with the steps given in Paragraph 12.

b. If the shelter and trailer are delivered separately, they may be installed on a 2½-ton 6 x 6 cargo truck as follows:

(1) Remove canvas cover, roof bows, and side framing from truck and drop tail gate.

(2) If a hoist is available, Shelter HO-17-(*) may be lifted by its four corners and placed on the truck body with the entrance door toward the rear. Bear in mind that the weight of the shelter with all equipment installed is about 1¾ tons.

If no hoist is available some method must be devised with the means at hand to raise the shelter to truck level and slide it on the truck. In this case the job is easier if the heavy items of radio equipment are removed from the shelter before lifting. This is easily and quickly done and is explained in Paragraph 23.

(3) Attach the clamps (2 on each side of the shelter) to the truck body sides to hold it firmly in place. If the cargo truck has a wood body, bolt in place the four clamp anchors. See the instruction leaflet covering Shelter HO-17-(*).

(4) Mast Base Brackets MP-50-A, Mast Bases MP-48, and Mast Base MP-47 may have been removed and placed inside the shelter for shipping. Bolt Mast Base Brackets MP-50-A with Mast Bases MP-48 to the rear of the shelter as shown in Figure 2. Attach the short external lead wire between the mast bases and the lead-in bushings. Bolt Mast Base MP-47 in place on the roof of the shelter and attach the antenna lead wire between the binding post on the mast base, and

the binding post at the rear of Antenna Tuning Unit BC-939-A.

(5) Attach the bumper bracket for Cord CO-335 to the left-hand bumper at the rear of the truck as shown in Figure 12. No holes need be drilled in the truck, but if the truck body is of wood it will be necessary to chip away a small amount of wood from the floor beam which extends over the bumper.

(6) Extend Cord CO-335 through the hole and clamp in the rear of the shelter. Bring the outer plug down behind the truck body and clamp it into the bumper bracket.

(7) Attach the flexible section of the speaking tube to the fitting at the front of the shelter and route the speaking tube into the lefthand truck window. Hook mouthpiece of the speaking tube to any point on the inside of the truck convenient to the driver.

(8) Attach one end of each of the two ground straps provided to the terminal at the front and at the rear of the shelter respectively. If the truck has a metal body, bolt the other end of the ground straps securely to the nearest available point; or if the truck has a wood body, run the ground straps down to the nearest points on the chassis and clamp them securely.

(9) Couple the Trailer K-52-E to the rear of the truck and plug in Cord CO-316 to the receptacle clamped in the bumper bracket.

c. If shelter and trailer are to be used in a fixed location, the truck will not be necessary and may be released for other uses. In this case installation will be as follows:

(1) Select a location for the shelter on level ground away from power lines, tall trees or large obstructions, if possible. Considerations of cover will not always permit selection of the best location but in any case the best compromise between cover and a clear antenna should be used. If the ground is wet, block the shelter up as protection for the radio station components.

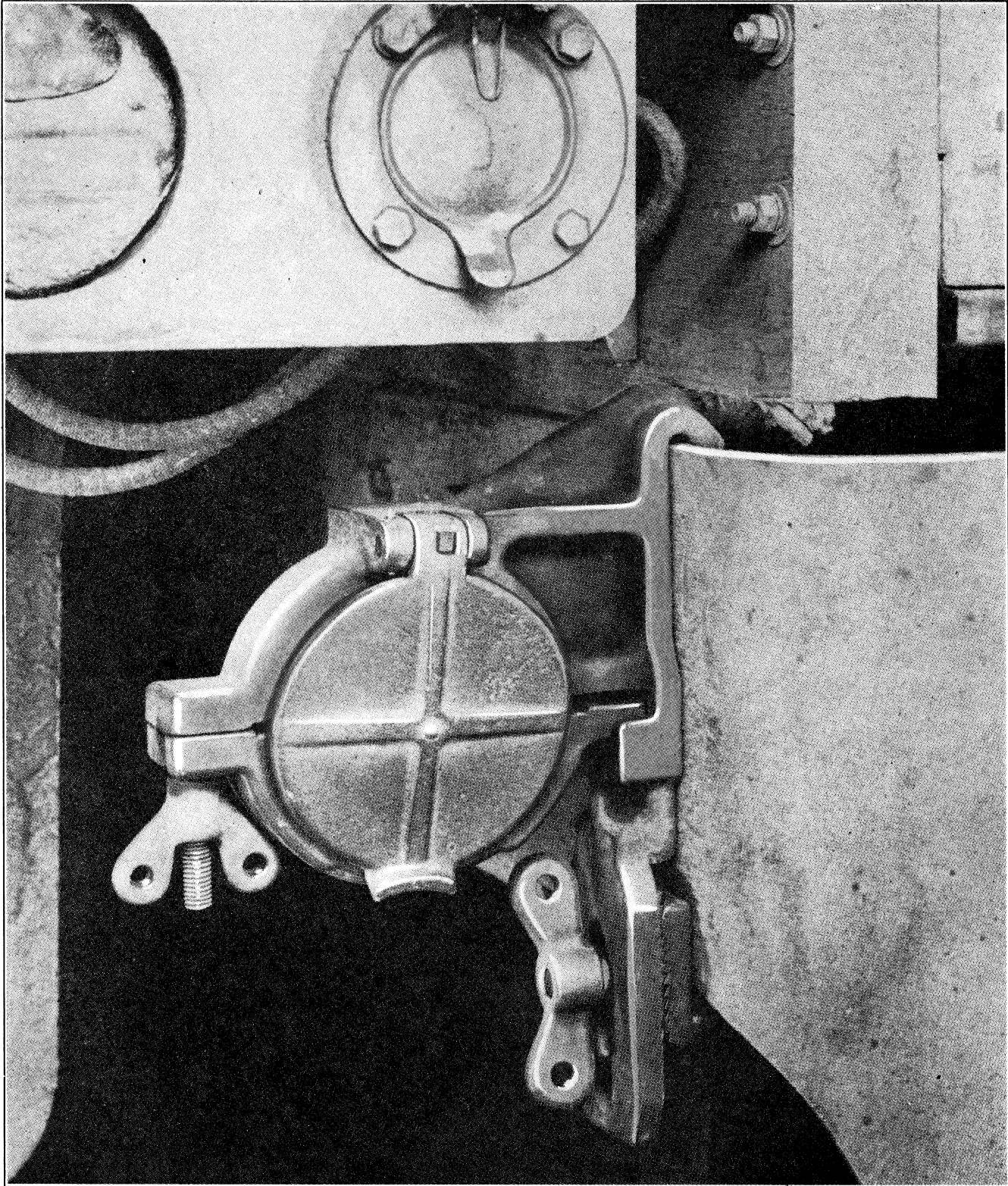

Figure 12—Bumper bracket for Cord CO-335, installed on bumper of 2½ ton 6x6 truck

(2) Place the trailer in any convenient position near the shelter. By proper use of the extension cords (see Paragraph 15 *h*), the trailer may be placed at a distance of up to 200 feet from the shelter.

(3) Apply such camouflage to the shelter and trailer as required.

(4) Follow instructions given in Paragraph 10 *b* (4).

(5) Connect Counterpoise CP-15-B to ground binding post at front of shelter. Lay the counterpoise on the ground and fan out the individual conductors radially.

(6) Bring out Cord CO-335 through clamp in rear of shelter.

(7) Connect Cord CO-316 to Cord CO-335 either directly or with extension cords.

11. Installation [SCR-499-(*)].

a. Components supplied with Radio Set SCR-499-(*) are as listed in Paragraph 9. Refer to Figure 5 for a general view of the operating components of Radio Set SCR-499-(*) as arranged for field operation. Except for the installation in the shelter, Radio Set SCR-499-(*) is identical both in connections and in operation with Radio Set SCR-399-(*).

b. Select a site for the station in accordance with the requirements of the station but wherever possible provide cover such as a tent or shed for the equipment. A station may be set up in open country if necessary but in any case protect the radio transmitter from rain or dirt. The other major components are provided with canvas covers which may be left on while operating and which will give protection against any but severe weather.

As an optional installation the equipment may be set up in any convenient vehicle according to the ingenuity of the installing personnel. The general arrangement may be similar to the photographs of the interior shown in this manual.

c. Set up the transmitter with the antenna tuner fastened in place on the top as shown in Figure 8. If the installation is made on bare ground block the transmitter up on wooden skids or planks to keep the base dry.

d. Either a long wire or a whip antenna may be used.

(1) If a long wire antenna is desired remove the antenna wire (100-foot roll) from Chest CH-120-A. Determine the length of the antenna wire from the following table.

Antenna Length	Desired Frequency Range
25 feet	2 to 10 M.C. or 15 to 18 M.C.
35 feet	2 to 6 M.C. or 11 to 18 M.C.
45 feet	2 to 4 M.C. or 10 to 18 M.C.
65 feet	2 to 3 M.C. or 9 to 18 M.C.

Anchor the outer end of the antenna to a tree or other support with a length of rope. Insert an antenna insulator between the end of the wire and the rope. Keep the antenna as high and free of surrounding objects as possible. Attach a lead-in to the antenna binding post on Antenna Tuning Unit BC-939-A.

(2) When using the whip antenna use Mast Base MP-59-A. The mast base mounts on the rear of the transmitter hooking to the bolts which hold the antenna tuning unit. Mount Mast Base MP-47 in the mast bracket and insert the five section whip antenna consisting of one each Mast Sections MS-49 to MS-53 inclusive.

e. Set up Chests CH-120-A and CH-121-A as shown in Figure 5, with the supporting legs inserted into the brackets on the ends of the chests.

f. Connect Power Unit PE-95-(*) with Junction Box JB-70-A in Chest CH-120-A by means of Cord CO-335 and Cord CO-316. Extension cords may be used to place the power unit farther from the station. A commercial source of power, if available, can be used instead of Power Unit PE-95-(*) to operate the station.

g. Connect Chest CH-109-A containing the 12-volt storage battery to Junction Box JB-70-A, using Cord CD-659. Connect also Rectifier RA-63-A for charging the storage battery to Junction Box JB-70-A. (See Figure 16.)

h. If the installation is made in an enclosure in regions where the weather is cold connect the electric heater.

i. Place Chest CH-89-A in front of the two operating chests to provide a bench for the operator.

j. The balance of the accessory components, including Chest CH-88-A and Chest CH-119-A may be placed nearby in any convenient position.

12. Preparation for Use [SCR-399-(*)].

a. As the operating components of Radio Set SCR-399-(*) are completely installed, mounted, and inter-connected by cables there should be no further installation work required other than assembly of antennae and a general inspection to see that:

(1) Power Unit PE-95-(*) is properly connected, both mechanically and electrically, to Shelter HO-17-(*).

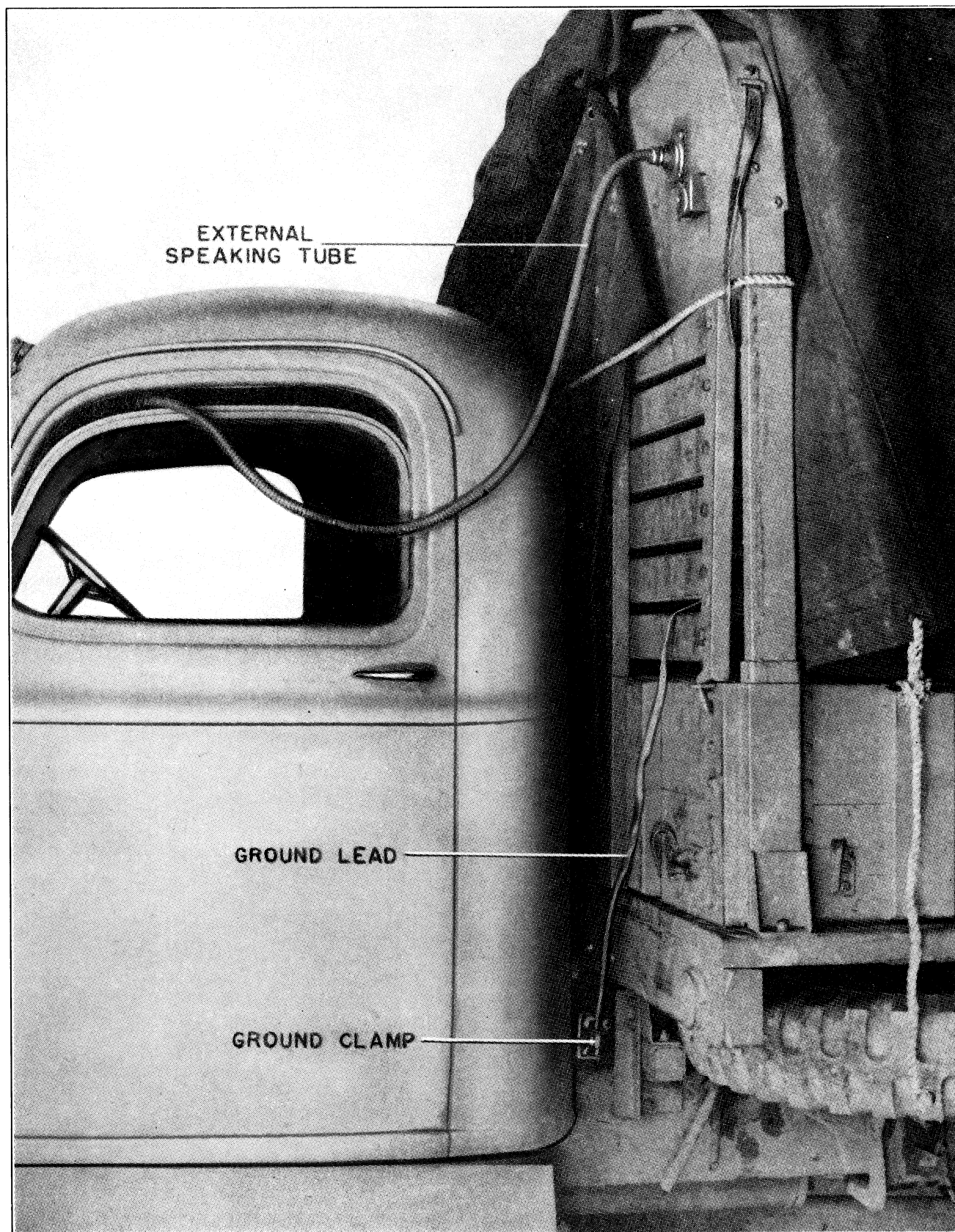

Figure 13—Front end of truck installation, showing ground connection and speaking tube

(2) Receivers, speech amplifier, and transmitter cords are properly plugged into their respective connections.

(3) All wing nuts, wing head-bolts, turn buckles, etc., are tight; read over thoroughly and perform every operation under "outline of inspection checks," Paragraphs 22 *b* and 22 *c*, in Section IV.

b. Now install the transmitting and receiving antennae. Proceed as follows:

(1) From Chest CH-89-A select:

(a) One Mast Section MS-49.

(b) One Mast Section MS-50.

(c) One Mast Section MS-51, to which a metal S link has been attached (for guying down the transmitter antenna).

(d) Two Mast Sections MS-51.

(e) Three Mast Sections MS-52.

(f) Three Mast Sections MS-53.

(g) The insulated guy rope for transmitting antenna.

(h) Two insulated guy ropes for receiving antennae.

(2) Assemble transmitting antenna by:

(a) Screwing Mast Section MS-49 into Mast Section MS-50, using two pairs of gas pliers to tighten the connections.

(b) Repeat this procedure with Mast Sections MS-51, MS-52, and MS-53.

(c) Climb on roof of shelter with guy rope and the assembled antenna sections and screw Mast Sections MS-53 into Mast Base MP-47.

(d) Attach catches at rope end of guy rope to holes in corners of Mast Base Brackets MP-50-A.

(e) Standing on the center of the roof, grasp the antenna with outstretched hand at shoulder height and bend it backwards to a horizontal position.

(f) Holding the antenna down in this position, walk to rear of roof and with other hand pick up insulator end of guy rope and attach it to S link on Mast Section MS-51.

(3) Assemble left hand receiving antenna as follows:

(a) Screw Mast Section MS-51 into MS-52, using two pairs of gas pliers to make connection tight.

(b) In similar manner attach MS-53.

(c) Screw Mast Section MS-53 into Mast Base MP-48 on rear wall of shelter near roof.

(4) Assemble right hand receiving antenna by repeating steps (3) *a* and (3) *b*, and screwing

the assembled sections into Mast Base MP-48 on opposite side of shelter.

Note: After assembling mast sections, tape each joint.

(5) Attach insulator ends of receiving guy ropes to receiving antennae and the opposite ends to rear corners of truck or shelter to pull down antennae.

Note: These two guy ropes need only be used when driving in a city or under many low obstacles. In the country, better reception results with receiving antennae released to the vertical position.

c. Charts on Chest CH-88-A (wall), Chest CH-119-A (wall), and Chest CH-89-A (seat bench) will show where the miscellaneous accessory components are stored. Before proceeding further, it will be necessary to:

(1) Unpack four Batteries BA-30.

(2) Install two batteries in each Telephone EE-8-(*) in accordance with instructions outlined in its technical manual.

(3) Remove components for Frequency Meter Set SCR-211-(*) from packing case, and

(a) Install batteries as per technical manual.

(b) Stow spare batteries and extra spare tubes in Chest CH-88-A.

(c) Put the frequency meter in its bag, and its headset in the top pockets.

(d) Place the set in Chest CH-119-A and strap in place, using straps which have been bolted there for this purpose.

(4) Examine the cells of the storage batteries in Power Unit PE-95-(*) and in Chest CH-109-A. If batteries are dry, they have been shipped dry charged and it will be necessary to add electrolyte. Electrolyte of the specific gravity called for by the instructions accompanying each battery shall be used. In most instances, the electrolyte should have a specific gravity of 1.265 at 70 degrees Fahrenheit. The quantity of electrolyte required per 6-volt battery is 64 fluid ounces. To prepare sufficient electrolyte (specific gravity of 1.265) for four 6-volt batteries (two in Chest CH-109-A and two in Power Unit PE-95-(*)), proceed as follows: Carefully add 64 fluid ounces of sulphuric acid (electrolyte grade, 1.835 sp. gr. at 60 degrees Fahr.) to 192 fluid ounces of distilled water in a glass or rubber lined container of sufficient size. **Caution: Add acid to water slowly and stir well with glass rod; do not add the water to the acid.** After pouring this electrolyte into each battery cell equally (so the plates

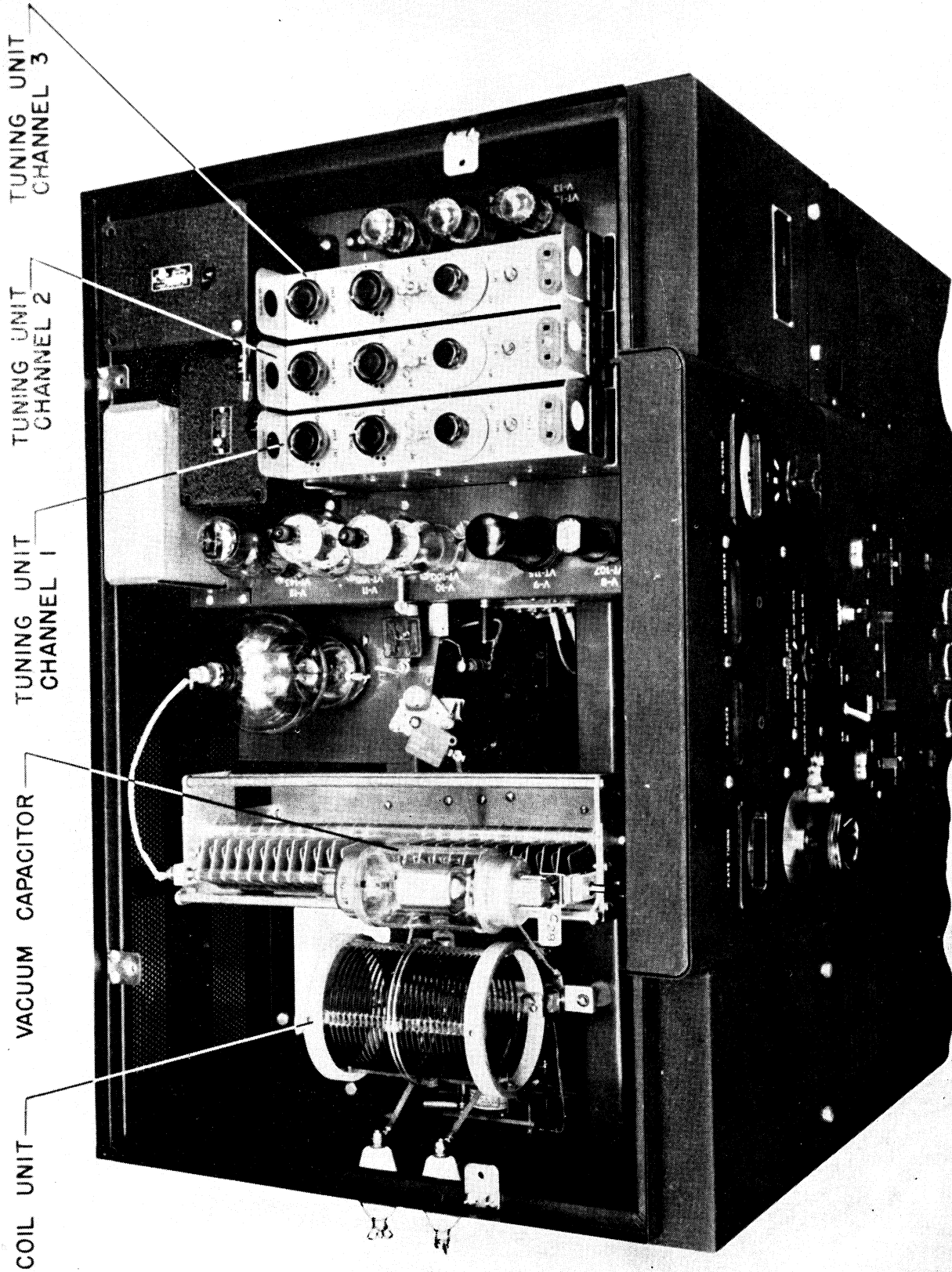

Figure 14—Radio Transmitter BC-610-E, top view, cover removed

are covered about $\frac{1}{4}$ " the vent caps having breather holes in them should be used to replace the airtight caps.

13. Preparation for Use [SCR-499-(*)].

a. Connect cords as shown in Figure 16, including:

(1) Cord CD-763 from transmitter to Junction Box JB-70-A.

(2) Cord CD-764 from transmitter to speech amplifier.

(3) Cord CD-565 from Radio Receiver BC-312-(*) to junction box.

(4) Auxiliary audio cord, key cord, and lamp cord from Chest CH-121-A to junction box.

(5) Connect Counterpoise CP-15-B to the ground binding post of the transmitter located on the left hand side near the front. Lay the counterpoise on the ground and fan out the individual conductors radially.

b. Using one each Mast Section MS-51, MS-52, and MS-53, form a three-section antenna and screw into antenna fitting on top of Chest CH-120-A.

c. Attach a similar antenna to top of Chest CH-121-A.

d. Follow Paragraph 12 *c.*

14. Precautions Before Operating.

a. Caution Note. Before attempting any operation of the equipment read Paragraphs 14 and 15 carefully. When thoroughly familiar with them, proceed with operation but bear in mind at all times the following precautions:

(1) Reread Safety Notice in front of book.

(2) Read the paragraphs on tuning procedure very carefully and always follow this procedure without deviation. Failure to do so may cause damage or shorten the life of the tubes.

(3) Be sure to follow paragraph 15 *f* (3).

(4) ***Never fill gasoline tanks of either truck or trailer with transmitter in operation.***

b. Before attempting to operate equipment within the shelter, proceed as follows:

(1) Turn the large ON-OFF switch, marked CIRCUIT BREAKER, on the control panel of the power unit OFF, and check the operation and condition of the power unit in accordance with its technical manual.

(2) When completely checked push the STOP button on the STOP-START switch on the control panel of the power unit and hold it in until the power unit stops. Some power units are being issued which contain a momentary

push-to-stop switch which does not require being held in until the power unit stops. In general: on Ford-powered units the stop button must be held in, while Willeys-powered units have the momentary push-to-stop switches.

(3) Set ON-OFF (CIRCUIT BREAKER) switch of the power unit at ON.

(4) On Speech Amplifier BC-614-E rotate the GAIN control knobs of both CARBON MIC. 1 and DYNAMIC MIC. 2 to their extreme counter clockwise positions (minimum gain).

(5) At Junction Box JB-70-A:

(a) Set the transmitter control switch at TRANS. OFF.

(b) Set C.W. SIDETONE switch at OFF.

(c) Set both receiver disabling switches, marked RECEIVER DISABLING, at ON.

(d) Set RECEIVER OUTPUT switch at NORMAL.

(e) Set REMOTE CONTROL EE-8 switch at NORMAL.

(f) See that the key plugs are in their proper jacks. Refer to Figure 16.

(g) Set BATTERY SOURCE switch at AUX.

(6) Set switch of electric heater at OFF.

(7) Make sure FILAMENT POWER and PLATE POWER switches of Radio Transmitter BC-610-E are set at OFF, and EXCITER PLATE POWER and HIGH VOLTAGE PROTECT switches are at NORMAL.

15. Transmitting.

a. Putting Station in Readiness.

(1) Push START button on Junction Box JB-70-A until Power Unit PE-95-(*) starts and normal line voltage (110 to 125 volts) is indicated on A.C. LINE VOLTAGE meter on the power unit.

(2) Turn on electric lights in Chest CH-120-A, Chest CH-121-A, and in shelter over transmitter.

(3) Remove two Headsets HS-30-(*) with Cords CD-605 from Chest CH-120-A. Connect one headset to the pair of jacks (marked HEADSETS) located to the left of the START-STOP switch and the other headset to the pair of jacks located to the right of the START-STOP switch. The left hand pair of headset jacks are supplied by Radio Receiver BC-312-(*) and the right hand pair of headset jacks are supplied by Radio Receiver BC-342 when the RECEIVER OUTPUT switch is set at NORMAL.

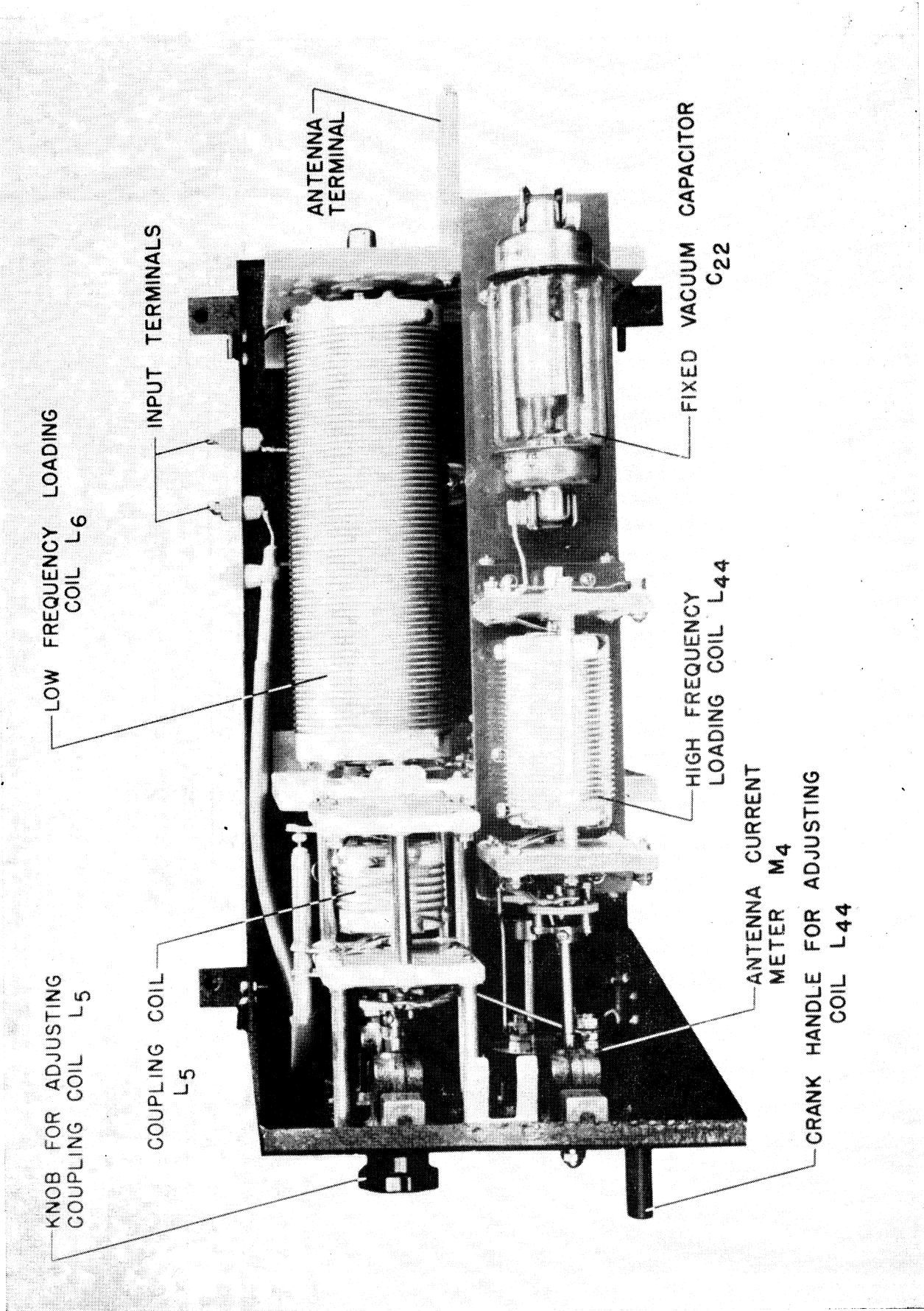

Figure 15—Antenna Tuning Unit BC-939-A, top view (cover removed)

(4) Check the operation and condition of Radio Receivers BC-312-(*) and BC-342-(*) as outlined in their technical manuals.

(5) Set SEND-REC. switches of receivers at SEND.

Caution: These switches should be in SEND position at all times. (See Paragraph 15 f (3).)

(6) Turn on electric heater or ventilating blower, if either is desired.

b. C-W Transmission.—Always adjust Radio Transmitter BC-610-E initially for c-w operation. This is accomplished by performing the following operations:

(1) See that the PLATE POWER switch of the transmitter is at OFF, and is left there. (See Caution, Paragraph 15 f (2).) Also make sure transmitter control switch on Junction Box JB-70-A is at TRANS. OFF.

(2) Set the FILAMENT POWER switch of the transmitter at ON. The green pilot lamp and the plate tuning dial should now light. The FIL. VOLTAGE meter should register. (Allow 1 minute for the filament to come up to temperature.)

(3) Adjust the FILAMENT VOLTAGE control of transmitter until the FIL. VOLTAGE meter indicates 5 to 5.3 volts.

(4) Select one tuning unit covering the desired frequency range from Chest CH-88-A (wall).

(5) Lift open the right hand door in the cover of the transmitter and firmly insert tuning unit in one of the three available channels, marked 1, 2, 3. (Locate the tuning unit so that the switch marked M.O.-XTAL faces the front panel of the transmitter. (See Figure 14.)

(6) Set BAND SWITCH on front panel of transmitter so its position number corresponds with the channel number where tuning unit was placed.

(7) Select from Chest CH-88-A (wall) one coil unit covering the desired frequency.

(8) Remove Capacitor CA-423 from Chest CH-88-A (wall) if operation in the 2.0 to 2.5 megacycle frequency range is desired.

(9) Lift open left hand door in cover of transmitter and insert coil unit (and Capacitor CA-423 if required).

(10) Set COUPLING control of Antenna Tuning Unit BC-939-A to 0 (zero).

(11) Set the CW-PHONE switch of transmitter at CW.

c. M.O. (Master Oscillator) Control.—Proceed as follows:

(1) Set M.O.-XTAL switch of the tuning unit at M.O.

(2) Set EXCITATION METER SWITCH on the front panel of the transmitter at INT. AMP. GRID.

(3) Set EXCITER PLATE POWER switch of the transmitter at ON.

(4) Loosen the thumbscrew lock on the M.O. dial and set this dial of the tuning unit to the desired frequency as indicated by the Tuning Chart of Radio Transmitter BC-610-E pertaining to the tuning unit in use. [For greater accuracy use Frequency Meter Set SCR-211-(*)]. Tighten the dial lock.

(5) Adjust the center knob of the tuning unit marked DOUB. for maximum reading as indicated on EXCITATION METER.

(6) Set EXCITATION METER SWITCH on the front panel of the transmitter at P. A. GRID.

(7) Adjust the INT. AMP. knob of the tuning unit for maximum reading as indicated on EXCITATION METER.

(8) Repeat steps (5) and (7) until the maximum possible deflection is obtained on EXCITATION METER. (EXCITATION METER will read between 60 and 100 ma.)

(9) Set EXCITER PLATE POWER switch at NORMAL (OFF).

(10) Make certain that both left and right doors in top cover of the transmitter are firmly closed upon the interlock switches, *otherwise plate power cannot be applied.*

(11) Set HIGH VOLTAGE PROTECT switch at HIGH VOLTAGE PROTECT. *Always do this before tuning up the final amplifier or the antenna tuning unit.*

(12) Set the transmitter control switch at Junction Box JB-70-A at TRANS. ON. The red pilot light on the transmitter should now light.

(13) Close the circuit of either Key J-37 by pressing the key. This key must be held down while making subsequent tuning adjustments. The P.A. PLATE meter should indicate some amount of current depending upon the setting of the PLATE TUNING wheel.

(14) Unlock the PLATE TUNING wheel by pushing down on the small knurled knob, and adjust this wheel until P.A. PLATE meter dips

to minimum reading. *Do not change this adjustment from this point.*

(15) Lock the PLATE TUNING wheel by pushing the lock lever to the right.

(16) On Antenna Tuning Unit BC-939-A:

(a) Set the antenna range switch knob at 2-10 MC. position if operating below 10 megacycles, or at 10-18 MC. if operating above 10 megacycles. (See Paragraph 15 *i* for information about LONG WIRE position of switch.)

(b) Set COUPLING knob to about 2.0.

(17) Ascertain from the tuning chart approximate setting of antenna tuning inductor for the frequency you have selected.

(18) Turn antenna tuning inductor crank to approach this setting and watch for an indication of rising current at the P. A. PLATE meter on the transmitter.

(a) If operating frequency is in range 2-10 MC., use crank marked "10 MC.,—2MC."

(b) If operating frequency is in range 10-18 MC., use crank marked "18 MC.—10 MC."

(19) Adjust the crank for maximum indication of the P.A. PLATE meter.

(a) If the value as indicated on this meter exceeds 100 milliamperes, decrease coupling by turning the COUPLING knob of BC-939-A counter clockwise.

(b) If the value as indicated on this meter falls below 100 milliamperes, increase COUPLING by turning knob clockwise or in the INCREASE direction until it reaches 100 ma.

(c) ANTENNA CURRENT meter of BC-939-A will now give some indication of antenna current.

(20) Now throw HIGH VOLTAGE PROTECT switch of transmitter down at NORMAL. Press Key J-37. Both P.A. PLATE meter of BC-610-E and ANTENNA CURRENT meter of BC-939-A will now indicate substantially higher readings.

(21) Adjust COUPLING control of the antenna tuning unit until the P.A. PLATE meter reads 290 ma.

(22) Now carefully reset inductor crank for maximum indication on ANTENNA CURRENT meter.

(23) Readjust COUPLING control and inductor crank by repeating (21) and (22) until maximum antenna current occurs when P.A. PLATE meter reads 290 ma.

Caution: *Never exceed a value of 300 ma. (c-w) as indicated by the P.A. PLATE current meter; it is permissible to reduce coupling so plate current is as low as 200 ma. if satisfactory c-w communication is still maintained. Do not readjust PLATE TUNING after once adjusted.*

See paragraph 15 *c* (13) above. A check will show that it remains approximately at minimum if instructions have been followed.

(24) Now release Key J-37. With the opening of this key, the EXCITATION, P.A. PLATE and ANTENNA CURRENT meters should all return to zero.

(25) Press either Key J-37 and check FIL. VOLTAGE meter. If necessary reset FILAMENT VOLTAGE knob until this meter reads 5.0 to 5.3 volts; then release key. The transmitter has now been tuned and is ready for c-w operation. Keying of the transmitter may be checked by pressing the key and noting meter indications. (Data on meter readings will be found in Chart of Performance Characteristics, Section V.)

(26) If a c-w telegraph transmission is not contemplated at the moment, throw the transmitter control switch on the junction box to TRANS. OFF position, thus shutting off plate power.

Note: *If it is desired to completely turn off the transmitter, set the FILAMENT POWER switch on Radio Transmitter BC-610-E at OFF.*

d. Crystal Oscillator Control.—Follow all the steps outlined in Paragraph 15 *b* (1) through (11), then proceed as follows:

(1) Set M.O.-XTAL switch of tuning unit at XTAL.

(2) Insert into XTAL jacks of tuning unit a Crystal Holder FT-171-B with crystal (or other suitable holder) of proper frequency.

(3) Set EXCITATION METER SWITCH of the transmitter at INT. AMP. GRID.

(4) Set EXCITER PLATE POWER switch of transmitter at ON.

(5) From here on, tune the transmitter by following steps (5) through (26) as outlined under Paragraph 15 *c*. At this point it may be helpful to remember that from 2 to 4 megacycles the crystal frequency is the same as the transmitter output frequency and the circuit controlled by the DOUB. knob on the tuning unit then operates as a buffer stage. From 4 to 12 mc. this stage acts as a doubler and hence the crystal frequency is one-half the output frequency. Thus, a crystal

whose frequency is, say, 2200 KC., may be used with Tuning Unit TU-47 to produce the same frequency in the transmitter output; or it may be used with Tuning Unit TU-50 to operate the transmitter on 4400 KC. From 12 to 18 megacycles this stage quadruples the crystal frequency, and thus a crystal of 4000 KC. will produce a transmitter output frequency of 16000 KC. (16 MC.).

e. To Tune the Transmitter for Voice Transmission.—Follow all the operations exactly as outlined in Paragraph 15 *b* (1) through (11), and in either Paragraph 15 *c* (1) through (26) (M.O. Operation), or Paragraph 15 *d* (1) through (5) (Crystal Controlled Operation), then proceed as follows:

(1) Make sure that the following controls on Junction Box JB-70-A are as follows:

(a) The transmitter control switch is at TRANS. OFF.

(b) The REMOTE CONTROL EE-8 switch is at NORMAL.

(c) The C.W. SIDETONE is at OFF.

(2) Set MODULATOR BIAS control on transmitter to extreme counterclockwise position. (This increases bias so MODULATOR PLATE meter will not indicate until further adjustments have been made.)

(3) Set CW-PHONE switch of transmitter at PHONE.

Caution: Never throw this switch while the final amplifier is turned on.

(4) Remove Microphone T-50 from its mount in Chest CH-120-A by lifting upward.

(5) Press the press-to-talk switch on the microphone and note that this puts transmitter carrier on the air. The P.A. PLATE meter should now read approximately 250 ma., which is the normal plate current for voice operation.

(6) Release the press-to-talk switch on the microphone.

Caution: Never exceed a value of 260 ma. as indicated by P.A. PLATE meter during voice operation.

(If transmitter has been tuned to 290 ma. (c-w) the plate current will be 250 ma. when switched to voice as the CW-PHONE switch automatically reduces final amplifier plate voltage.) If the P.A. PLATE meter reads more than 260 ma. the COUPLING Control on the antenna tuning unit should be adjusted until plate current is reduced to proper value.

(7) Hold the microphone in the left hand, press the press-to-talk switch, and with right hand adjust MODULATOR BIAS control of transmitter until MODULATOR PLATE meter on Speech Amplifier BC-614-E indicates 40 ma. Release press-to-talk switch.

(8) Hold the microphone in normal speaking position (position varies with voice characteristics, from 2 to 6 inches from mouth), press the press-to-talk switch and talk into microphone.

(9) While pressing the switch and talking into microphone adjust GAIN control (DYNAMIC MIC. 2) on the speech amplifier until the MODULATOR PLATE meter indicates approximately 200 ma. on voice peaks. If its pointer swings higher than 200 ma. on extreme voice peaks reduce GAIN control to prevent exceeding 200 ma. as this figure represents 100 per cent modulation when the transmitter is fully loaded. This procedure applies to carbon microphones as well. Only one GAIN control should be open at a time however.

(10) Release press-to-talk switch, taking the transmitter off the air. Voice transmission may now be immediately accomplished by pressing the press-to-talk switch and talking into the microphone.

(11) With the REMOTE CONTROL EE-8 switch in either TELEPHONE position, voice transmission without press-to-talk control of transmitter may be obtained by setting the transmitter control switch to TRANS. ON during transmission periods and to TRANS. OFF to terminate transmission, but this procedure is not recommended for general practice.

(12) To turn off transmitter completely, set FILAMENT POWER switch at OFF.

f. Transmitter Operation.—When operating Radio Transmitter BC-610-E, it will be helpful to remember the following:

(1) The principal switch used to control the transmitter is the transmitter control switch located at Junction Box JB-70-A, operated between its upper (TRANS. ON) and neutral (TRANS. OFF) position, for c-w operation, and the press-to-talk switch on the hand microphone for phone transmission.

(2) The PLATE POWER switch on the transmitter must always be left at OFF otherwise automatic disabling of the receivers is not possible. (This switch is used only in emergency or during servicing if the transmitter is away from the truck.)

(3) Always leave the RECEIVER DISABLING switches at ON to avoid burning out the receiver input circuits. The only exception to this is when it is desired to monitor a frequency other than the transmitter frequency during transmission, in which case the corresponding RECEIVER DISABLING switch can be set at OFF. This is only true, however, when the frequency to be monitored is considerably different from the transmitter frequency, and is not at a harmonic of the transmitter frequency; otherwise, damage to the receiver will result. The disabling short-circuits the receiver input connections to protect the antenna coils and also short-circuits the loudspeakers to prevent acoustic feedback to the dynamic microphone.

a. The disabling is ready to function when the receiver SEND-REC switches are in SEND position, and the Junction Box JB-70-A's RECEIVER CONTROL switches are set at AUTO.

b. Disabling of receiver occurs automatically, as follows:

1. In c-w operation, with the transmitter control switch at TRANS. ON, when either Key J-37 is closed.

2. In voice operation, when the transmitter control switch is set to TRANS. ON with the REMOTE CONTROL EE-8 switch in either TELEPHONE position; or when it is set to TRANS. OFF and the press-to-talk switch is pressed on either Microphone T-50, carbon Microphone T-30-(*) (throat), or on carbon Microphone T-17.

Caution: Automatic disabling CANNOT occur unless PLATE POWER switch on transmitter is at OFF.

(4) Changing Type of Emission.—

(a) After the transmitter has been tuned for voice operation as outlined in Paragraph 15 e, it can be immediately switched to c-w operation by setting the CW-PHONE switch at CW and setting the transmitter control switch to TRANS. ON, without further tuning adjustments.

(b) The transmitter can then be switched back to voice operation by *first restoring the transmitter control switch to TRANS. OFF, and then setting the CW-PHONE switch at PHONE.*

(5) Besides the use of Microphone T-50 there are three additional means of modulating the transmitter. They are:

(a) Microphone T-30-(*) (throat), for use if gas masks must be worn. The plug on the end of the cord of this microphone can be in-

serted in the CARBON MIC. 1 jack on the speech amplifier and the adjacent GAIN knob will control its input level. Its press-to-talk switch will operate the transmitter.

(b) Microphone T-17. It is plugged in and used in exactly the same way as microphone T-30-(*).

(c) Handset TS-9-(*) of the Telephone EE-8-(*) which is connected to Junction Box JB-70-A. This handset is stored in the right hand compartment in Chest CH-120-A. When the transmitter control switch on the junction box is set at TRANS. ON with the REMOTE CONTROL EE-8 switch in either TELEPHONE position, and the press-to-talk switch on the handset of Telephone EE-8-(*) is pressed, it is possible to modulate the transmitter. The GAIN control of DYNAMIC MIC. 2 provides adjustment of the input level from the handset. In this case the press-to-talk switch does not control the transmitter, but merely connects battery current to the microphone. Throwing the transmitter control switch down to REC. TO EE-8 connects the output of one receiver to the earpiece of the handset; the receiver to be used is selected from position BC-312 or position BC-342 of the REMOTE CONTROL EE-8 switch on the junction box

(6) In addition to the keying facilities (Key J-37) located in the operating chests, Key J-45 may be used to key the transmitter at the auxiliary key jack (KEY) located on the front panel of the speech amplifier. Keying the transmitter at the auxiliary key jack will be necessary if the source of 12 volt d-c power fails since this is the only direct connection to the cathode circuit of the oscillator stage. Since Relay RY₂₀₀ does not function with this method of keying automatic disabling cannot occur hence extreme caution should be exercised when operating in this manner. Refer to Paragraph 15 f (3).

(7) Changing Frequency, Case 1.—Provision is made in the transmitter for simultaneously accommodating three tuning units each of which may be instantly selected by the BAND SWITCH. Each tuning unit may be tuned to a separate frequency and left plugged in, ready for use when needed. Since there are three complete sets of tuning units it is possible to install three tuning units of the same range, which could be covered by one coil unit. With each tuning unit pretuned to a different frequency within the range, change of transmitting frequency is accomplished then as follows:

(a) Set transmitter control switch at TRANS. OFF, (if operating c-w) or, release press-to-talk switch (if operating voice).

(b) Reset BAND SWITCH to desired frequency.

(c) Set HIGH VOLTAGE PROTECT switch at HIGH VOLTAGE PROTECT.

(d) Set transmitter control switch to TRANS. ON and close key (for c-w) or press press-to-talk switch (voice).

(e) Slightly retune PLATE TUNING wheel for dip in P.A. PLATE meter.

(f) Adjust antenna tuning indicator crank for rise in indication of P.A. PLATE meter.

(g) Throw HIGH VOLTAGE PROTECT switch down to NORMAL.

(h) Adjust COUPLING control of antenna tuning unit until P.A. PLATE meter reads 290 ma. (c-w) or 250 ma. (voice).

(i) Reset inductor crank for maximum indication of ANTENNA CURRENT METER.

Note: When difference in frequency is small only steps (a), (b), and (d) may be necessary, though disregarding other steps is not recommended.

(8) Changing Frequency, Case 2.—When the three tuning units plugged into the transmitter cover two or more different frequency ranges it is necessary when band switching during operation from one frequency to another to observe these precautions:

(a) Before moving BAND SWITCH to desired frequency open cover door over coil unit and determine if the frequency range of the coil unit is correct. If not, remove it, and place in Chest CH-88-A.

(b) Set BAND SWITCH to desired frequency.

(c) Install coil unit of proper frequency obtained from Chest CH-88-A.

(d) Close cover doors.

(e) Assuming tuning unit has already been tuned previously, it will be necessary to tune the final and antenna circuits as outlined in the step by step procedure in Paragraph 15 b (11) and 15 c (10) through (26) for c-w operation; throw the CW-PHONE switch to PHONE at the completion of retuning; if voice operation is required.

(9) Tuning units may be tuned up in the transmitter one after another by following the steps in Paragraph 15 c (1) through (9) for

M.O., or Paragraph 15 d (1) through (4) and Paragraph 15 c (5) through (9) for crystal control.

(10) When station is in motion it is advisable to speak very close to the microphone with lips almost touching it so as to exclude unwanted noises. This requires readjustment of the GAIN control on the speech amplifier to avoid over-modulation.

(11) During transmission on critical frequency (such as 2 to 2.5 megacycles) under certain conditions of unusual weather or altitudes high above sea level, extreme voice peaks may cause flashovers resulting in tripping the overload relay, momentarily interrupting communication until it is reset. Should this condition ever arise, it may be circumvented by:

(a) Switching to a favorable operating frequency, or

(b) Stopping the truck and transmitting from a fixed position after unguying the antenna and inserting one or two Mast Sections MS-54, to provide added height, or

(c) Using an auxiliary transmitting antenna, or

(d) Decreasing setting of COUPLING control on the antenna tuning unit until the P.A. PLATE meter reads 200 to 210 ma.

Caution: Do not reduce below 200 ma. Under this condition less modulation is required, hence the GAIN control should be adjusted so voice peaks do not cause swings above 150 ma. on the MODULATOR PLATE meter.

(12) OVERLOAD RESET switch. If the high voltage circuits are overloaded (as by excessive plate current plus heavy modulation), the overload relay will trip and shut off plate power. In this case, press the OVERLOAD RESET switch on the front panel of the transmitter and proceed with transmission. If the overload persists, check tuning adjustments and meter readings.

g. Remote Control of Transmitter.—A complete description of the equipment and facilities provided for remote control will be found in Paragraph 8 a (2) (b) and (c). Below are enumerated the steps to be followed in connecting up the remote control equipment:

(1) Remove unconnected Telephone EE-8- (*) from its mounting compartment in Chest CH-121-A. Before leaving the truck make sure its batteries are in good condition and screw switch is set to L. B.

(2) Remove Junction Box JB-60-A and Key J-45 from Chest CH-121-A.

(3) Remove Axle RL-27-B from Chest CH-89-A for use with either or both Reels DR-4 which should be dismantled, as required, from Frame FM-59-A.

(4) Carry Telephone EE-8-(*), Junction Box JB-60-A, and Key J-45 to the point where remote control is to be established.

(5) Connect the cord of Junction Box JB-60-A with Telephone EE-8-(*) at terminals L_1 and L_2 .

(6) Insert the plug on the cord from Key J-45 into the jack on Junction Box JB-60-A.

(7) Using Wire W-110-B from Reel DR-4 run line between remote station and the radio station in the truck. (If less than one full reel of wire is used, do not cut the wire, but pull out the inner end from center of reel.) In some cases it will be more convenient to leave the reels of wire in Frame FM-59-A and pay out the wire through the fairleads in the back of the shelter.

(8) Connect the two leads of one end of the line to the two line terminals on Junction Box JB-60-A.

(9) Connect the leads at the other end of the line to terminals marked REMOTE TELEPHONE outside Junction Box JB-70-A.

(10) The telephone at the remote station is now connected to the telephone in the truck. Communication between these points may be established by operating Telephones EE-8-(*) in accordance with instructions contained in the technical manuals for this equipment.

(11) The remote station may now instruct the radio operator at the truck to turn on the radio transmitter for voice operation and to adjust the speech amplifier gain so the remote station can properly modulate the transmitter. This is accomplished by exactly the same procedure as outlined in Paragraph 15 *f* (5), (c). It should be noted that both telephones are now on the same circuit, consequently both share the same facilities. Hence the radio operator may switch in the output of either receiver so it may be heard at the remote station.

(12) Since press-to-talk operation of transmitter from the telephones is not possible at either end, the remote operator should signal the radio station operator when end of transmission is desired so latter can throw the transmitter control switch to obtain reception or shut down the station, as required.

(13) If remote keying of c-w transmission is desired, the radio station operator should be instructed to place the transmitter in c-w operation and to set the REMOTE CONTROL EE-8 switch on Junction Box JB-70-A to either TELEGRAPH position, whereupon Key J-45 may be used to accomplish keying.

(14) Remote keying of transmitter in two way communication or net operation may be employed without the assistance of radio station operator, if an independent means of reception is available at the remote station. Latter is accomplished by removing Chest CH-121-A and necessary accessories to remote operating position. (See Paragraph 16 *b*.)

(15) Remote control of the transmitter may also be accomplished through use of the additional wire on Reels DR-4 carried on mounting FM-59-A. This mounting is located at the rear of the shelter to allow the wire to be fed out directly through the fairleads in the rear wall while the truck is in motion.

h. Extension Cables.

(1) To operate trailer 100 feet from truck:

(a) Remove the plug on the trailer power cord from the plug underneath rear of the truck; also disconnect the cable which delivers power to the trailer's running lights.

(b) Unhitch trailer from the truck.

(c) Drive the truck to any point up to 100 feet from the trailer.

(d) Remove Cord CD-652 from Chest CH-119-A.

(e) Insert one end into plug in rear of truck, then insert the other end into plug on power cord of trailer. Operation may now proceed normally.

(2) Operation of trailer 200 feet from truck:

(a) Proceed as in (1) (a) and (b) above but drive the truck to any point up to 200 feet from the trailer.

(b) Remove Cords CD-652 from Chest CH-119-A, CO-314 from seat bench, and CO-313 from Chest CH-112-A in trailer.

(c) Insert one end of Cord CD-652 in the power plug at rear of truck and into the other end of this cord insert the plug of Cord CO-314.

(d) Twist the leads of Cord CO-314 around the terminals of Cord CO-313, and tape up these connections.

(e) Insert the plug on Cord CO-313 into the power plug at the trailer. Since this is an

emergency measure not ordinarily used, it will be necessary to start or stop Power Unit PE-95-(*) at the trailer instead of at the truck.

(3) Operation of radio set from commercial power source: Operation from a commercial source of 117 volts, 50 or 60 cycle, single phase a-c may be effected as follows:

(a) Plug one end of Cord CD-652 into power plug at rear of truck and into the other end plug Cord CO-314.

(b) Connect the leads from the other end of Cord CO-314 directly to the source of power.

(4) To furnish power for auxiliary purposes from Power Unit PE-95-(*):

(a) If the radio set is not in use, power may be supplied at distances up to 200 feet from Power Unit PE-95-(*) as follows:

1. Remove the plug of the trailer power cord from the plug at the rear of the truck.

2. To the trailer power cord connect one end of Cord CD-652.

3. Into the other end plug Cord CO-313. The load may now be connected to the terminals at the end of Cord CO-313 and the power unit started.

(b) If Radio Set SCR-399-(*) or SCR-499-(*) must be used while the auxiliary power is being generated, proceed as follows:

1. Leave the trailer connected and hitched to the truck.

2. Connect the terminals of Cord CO-313 to the a-c terminals on the power panel of Power Unit PE-95-(*).

3. Onto the other end of Cord CO-313 plug Cord CO-314.

4. Connect the bare ends of CO-314 to the load. With the radio set in full operation, including the heater, this additional load should not exceed 1 KW. If the heater is not being used, the additional load may be 2.5 KW. Before operating in this manner check the power capabilities of the power unit you have.

i. Auxiliary Transmitting Antenna.

(1) Where the radio set may be used in a fixed location an auxiliary transmitting antenna will give considerably higher signal strength for transmitting.

(2) The table and chart in Section V shows frequency ranges which can be covered by various lengths of antennae. For example, a 45-foot length

of wire will operate satisfactorily from 2 to 4 megacycles and from 10 to 18 megacycles.

(3) Cut off the proper length from the roll of antenna wire stored in Chest CH-121-A. Scrape enamel insulation from one end and attach to Mast Base MP-47 by twisting around the base of one Mast Section MS-53, which is then screwed in tightly. Attach the other end to one of the spare insulators in Chest CH-89-A, and by means of a length of rope (also stored in Chest CH-89-A) secure it to a tree, high pole or other support as high and as free from surrounding objects as possible. *Never run it close to the receiving antennae.*

(4) Make adjustments of the tuning units and PLATE TUNING exactly the same as when using the whip antenna. Settings of the controls on Antenna Tuning Unit BC-939-A will be different. It will be found that considerably fewer turns of the loading coil should be used than with a whip antenna and in the medium frequency range, (from about 8 to 12 megacycles), it may be necessary to set the switch on the front of the antenna tuning unit at LONG WIRE. Except for this, the antenna tuning adjustment should be made following the same rules as with the whip antenna.

16. Reception.—Radio Sets SCR-399-(*) and SCR-499-(*) are equipped with one each Radio Receiver BC-312-(*) and BC-342-(*).

a. Operation of Receivers.—Complete information on operation will be found in Technical Manual TM 11-850 for Radio Receivers BC-312-(*) and BC-342-(*) which is included as an accessory of this radio set. However, the operation of these receivers in the radio set should be conducted with the thought that they are not separate components, but rather, interconnected parts of the radio station. To prolong the life of and obtain maximum benefit from these receivers, the following points should be noted concerning their operation.

(1) The REC-SEND switches of both receivers should be set at SEND at all times.

(2) Automatic disabling of receivers during periods of transmission should be observed at all times unless the received frequency is not near the fundamental or second harmonic of the transmitted frequency.

(3) Automatic disabling of both receivers is accomplished by setting the two RECEIVER DISABLING switches of Junction Box JB-70-A at AUTO.

(4) Automatic disabling is removed from receivers by setting the RECEIVER DISABLING switches to MAN. Each receiver has its separate switch.

(5) Sidetone may be switched to the headset jacks on Junction Box JB-70-A by setting C-W SIDETONE switch on Junction Box JB-70-A at TO BC-312 or TO BC-342. This permits use of headsets to monitor keying of c-w transmissions, whether receivers are disabled or not. Keep the C-W SIDETONE switch at OFF when using voice transmission.

(6) All power, antenna, and output wiring to receivers has been installed as a part of the radio station.

(7) Receiver output wiring for Loudspeakers LS-3 and for Headsets HS-30-(*) is brought out to switch connections on the junction box where the transpose switch and jacks for headsets are located. Two jacks in parallel are provided for each receiver output so both operators may listen to the same receiver.

(8) The RECEIVER OUTPUT switch of Junction Box JB-70-A reverses the speakers and jacks from one receiver to the other as follows:

(a) With RECEIVER OUTPUT switch set at NORMAL, the loudspeaker mounted above Radio Receiver BC-342-(*) , and the jacks to the right of the START-STOP switch on the panel of the junction box are all connected to this receiver; the same holds true with respect to Radio Receiver BC-312-(*) , its speaker, and jacks.

(b) With RECEIVER OUTPUT switch in TRANSPOSE position, the speaker and jacks normally connected to Radio Receiver BC-342-(*) are switched to Radio Receiver BC-312-(*) and latter's speaker and jacks are transposed to the other receiver. Thus if one operator is tuning the transmitter, or typewriting, the other can monitor both receivers or switch from one to the other instantly.

Caution: Read Paragraph 15 a (4) and Paragraph 15 f (3).

b. Remote Receiver Operation.—When necessary Chest CH-121-A with Radio Receiver BC-312-(*) may be removed from the truck to a remote point for operation. This is accomplished as follows:

(1) Disconnect antenna lead from fitting at top of chest.

(2) Disconnect key cord and phone-speaker cord between Chest CH-121-A, and Junction Box JB-70-A.

(3) Disconnect Plug PL-114 of Cord CD-565 from Socket SO-94 on receiver.

(4) Disconnect ground strap from terminal under Chest CH-121-A.

(5) Loosen turnbuckles holding Chest CH-121-A to table frame in Shelter HO-17-A after removing safety wires from wing nuts.

(6) Remove Chest CH-121-A from shelter.

(7) Remove Chest CH-109-A (12-V battery), after pulling out plug of Cord CD-659.

(8) Remove 4 legs from top of Chest CH-120-A, and one each Mast Sections MS-51, 52, and 53 from Chest CH-89-A.

(9) Transport the two chests, the legs, mast sections, and Cover BG-143-A to desired location.

(10) Set Chest CH-121-A up on its legs. (See Figure 10.)

(11) Remove Cord CD-690 from Chest CH-121-A, connect between Chest CH-109-A and receiver.

(12) Screw mast sections together and into fitting in top of Chest CH-121-A.

(13) Remove headset from Chest CH-121-A and plug into jack of Radio Receiver BC-312-(*) . Receiver is now ready for operation.

(14) If the radio station is to be operated with Chest CH-109-A removed as described above, turn on Rectifier RA-63-A to FULL CHARGE to furnish 12 V. power for relays.

17. Battery System.

a. The 12-volt battery system is used to furnish power for Radio Receiver BC-312-(*) as well as for operating the keying relay and disabling relays.

b. With the BATTERY SOURCE switch on the Junction Box JB-70-A at AUX., the 12-volt supply is obtained from the 12 V. battery in Chest CH-109-A.

c. Rectifier RA-63-A charges the battery in Chest CH-109-A. When using this battery, turn switch on the rectifier to TRICKLE CHARGE. If the battery is low, set the switch on the rectifier to FULL CHARGE.

d. Keep the battery fully charged at all times.

e. Some Power Units PE-95-(*) are provided with 12 V. terminals. With Cord CO-316 connected to these terminals, the 12 V. supply may be obtained from the power unit by setting the battery switch on Junction Box JB-70-A to PE-95.

f. With Chest CH-121-A and Chest CH-109-A removed from the shelter as described in Paragraph 16 **b**, the 12-volt supply for the radio station relays is obtained from Rectifier RA-63-A, with its switch at FULL CHARGE.

SECTION III—FUNCTIONING OF PARTS

	<i>Paragraph</i>
Radio Transmitter BC-610-E	18
Antenna Tuning Unit BC-939-A	19
Speech Amplifier BC-614-E	20
Junction Box JB-70-A	21

18. Radio Transmitter BC-610-E.

a. Mechanical Construction.—Radio Transmitter BC-610-E is assembled into a sheet steel cabinet with chassis decks. All metal parts are protected by plating or paint. The assembly consists of three principal decks or chassis on which are mounted the component parts of the transmitter together with a front panel on which are mounted external controls and indicating instruments.

(1) The upper section includes all radio frequency components, all indicating instruments and filament supply for the radio frequency tubes. Provision is made for plugging in tuning units to accomplish transmission at various frequencies. These tuning units and the components of the top deck are shown in Figure 14. On the front panel of the upper section (see Figure 8) are located meters for indicating the following: doubler plate current, or intermediate amplifier plate current, intermediate amplifier grid current, power amplifier grid current, power amplifier plate current, and power amplifier filament voltage. There are also switch SW_{11} for selecting any one of three tuning units (which have been pre set to a predetermined frequency), Switch SW_8 for connecting meter M_1 into various circuits, and a control for tuning the power amplifier plate circuit.

(2) The center chassis contains all of the audio and modulator sections which are not included in Speech Amplifier BC-614-E. Also included in this chassis is the rectifier supplying the power for the bias and audio driver circuits, and for the plate transformer for the exciter plate rectifier.

(3) The lower chassis includes the complete high voltage power supply together with its overload relay. This chassis also serves as the base for the entire transmitter and is fastened by large wing bolts into the shock mounting cradle which fastens the transmitter to the floor.

(4) The lower section of the front panel includes control switches for handling power application, the C.W.-PHONE switch, a reset switch

for the overload relay and controls for setting the filament voltage and the modulator bias.

(5) Access to the two lower sections is gained by removing the rear screen of the transmitter. Access to the top of the r-f section is gained by removing the entire top cover. These are removed by loosening the proper wing bolts.

b. Radio Frequency Section.—Electrically, the radio frequency section of the transmitter includes oscillator tube V_8 , doubler or buffer tube V_9 , intermediate amplifier tubes V_{10} and V_{11} and power amplifier tube V_{16} together with their associated tuning circuits. (See Figure 19).

(1) Oscillator tube V_8 is a Tube VT-107 (commercial type 6V6), the function of which is to provide excitation to the following stage at the desired frequency.

(a) The actual frequency of oscillation is determined by a tuned circuit consisting of a master oscillator coil in parallel with a variable capacitor and a fixed capacitor. One end of this coil is connected to the grid of oscillator tube V_8 through a series capacitor. A tap on the master oscillator coil connects through capacitor C_1 to the cathode of tube V_8 to provide feedback.

(b) The grid of oscillator tube V_8 is connected to ground through choke CH_1 and grid resistor R_1 . The cathode of V_8 is connected to ground through r-f chokes CH_2 and CH_3 (the low potential end of which is by-passed by capacitor C_3) and through the telegraph key so that operation of the key makes and breaks the generation of oscillation and provides for telegraph transmission. To maintain a high impedance between cathode and ground of tube V_8 , a capacitor and coil combination has been placed in series in the circuit.

(c) As an alternative to the adjustable master oscillator, crystal control of a fixed frequency may be provided. The crystal which is plugged into the jacks provided is connected across the grid to the cathode circuit of tube V_8 and becomes the frequency determining element.

(d) The screen grid of oscillator tube V_8 receives its voltage through resistor R_3 and is by-passed by capacitor C_2 . Screen voltage is maintained constant by voltage regulator tube V_{13} . Tube VT-139, connected between screen grid and ground.

(e) The plate of oscillator tube V_8 receives its voltage through resistor R_2 and radio frequency choke CH_3 . This voltage is held constant by voltage regulator tubes V_{14} and V_{15} , Tubes VT-139, which are connected in series to maintain a potential of 300 volts on the plate of the tube. Radio frequency voltage is prevented from returning into the plate power circuit by by-pass capacitor C_5 .

(f) The radio frequency power generated in the tube V_8 is fed to the grid circuit of buffer or doubler tube V_9 from the plate of tube V_8 through capacitor C_{13} . The screen grid of tube V_8 acts as a shield to prevent reaction on the oscillator frequency from changes in tube V_9 .

(2) Doubler or buffer tube V_9 is a Tube VT-115 (commercial type 6L6).

(a) Tube V_9 obtains its grid voltage partly as a result of the voltage drop across grid resistor R_{23} and partly as the result of the voltage drop across cathode resistor R_{24} . Screen voltage is obtained through resistor R_{25} and is by-passed by capacitor C_4 . The plate circuit of tube V_9 is resonated by a tuned circuit consisting of a coil and capacitor in parallel, which are contained in the tuning units.

(b) When using the master oscillator the plate circuit of tube V_9 is always tuned to twice the frequency of the master oscillator circuit. This further prevents reactions between the oscillator and the following stages which would cause instability of operation.

(c) When using crystal control in the frequency range of 2 to 4 megacycles, the crystal is operated at the same frequency as the output circuit of the transmitter. When operating in the frequency range of from 4 to 12 megacycles, the crystal is operated at one-half of the output frequency. In other words, tube V_9 operates as a buffer amplifier when using crystal control between 2 and 4 megacycles and operates as a doubler between 4 and 12 megacycles. In the frequency range from 12 to 18 megacycles the crystal is operated at one-quarter of the output frequency.

(d) Radio frequency voltage from the tuned circuit of tube V_9 is prevented from returning to the power circuit by radio frequency choke

CH_5 and by-pass capacitor C_{26} . Radio frequency voltage from the plate of tube V_9 is fed to the grids of intermediate amplifier tubes V_{10} and V_{11} through parasitic resistors R_{21} and R_{22} and blocking capacitor C_{14} .

(3) Intermediate amplifier tubes V_{10} and V_{11} are both Tubes VT-100 (commercial type 807).

(a) The intermediate amplifier tubes receive their bias through r-f choke CH_7 and resistor R_8 from the main bias power supply. The direct current bias voltage is sufficient to cut off the plate current of these tubes when no excitation is present, as during periods when the key is up.

(b) The screen grids of tubes V_{10} and V_{11} are supplied with power through resistors R_6 and R_7 and are by-passed by capacitors C_6 and C_7 .

(c) The plate circuits of tubes V_{10} and V_{11} are resonated by a simple tuned circuit consisting of a coil and a capacitor located in the tuning unit. Plate power is supplied through radio frequency choke CH_6 and is by-passed by capacitor C_{24} .

(d) The output of the intermediate amplifier stage is fed to the grid of power amplifier V_{16} through capacitor C_{15} .

(4) Tube V_{16} , Tube VT-220 (commercial type 250TH), is used as a neutralized class C power amplifier.

(a) Grid bias is supplied through choke CH_8 and is provided by the main bias voltage power supply. With key up, the direct current bias voltage is of a sufficient value to cut off the plate current of the tube. With key down, the voltage at radio frequency applied from the intermediate stage is sufficient to cause the grid to draw a considerable amount of current.

(b) The filament of tube V_{16} is by-passed by capacitors C_9 and C_{10} .

(c) Plate voltage is supplied through r-f choke CH_4 shunted by resistor R_9 for parasitic suppression. This plate voltage is by-passed to ground through capacitor C_{11} and is fed through the center tap of output coil L_7 . The plate circuit is tuned by output coil L_7 , plate tuning capacitor C_{12} and, only in the range of 2 to 2.5 megacycles by additional padding capacitor C_{28} .

(d) The plate circuit is center tapped so that an equal out-of-phase voltage is present for feeding back to the grid through blocking capacitor C_{29} and neutralizing capacitor C_{18} . Neutralizing capacitor C_{18} cancels the effect of the grid-plate capacitance so that the tube will operate as an amplifier without oscillation of its own.

(e) The radio frequency output power is taken from the tank circuit by a coupling coil which is wound around the outside of the output tank coil. The output power so obtained is then fed to Antenna Tuning Unit BC-939-A.

c. Modulator Section.

(1) Audio frequency speech currents enter the transmitter at terminals 6 and 7 of receptacle SO₅ on the rear of the modulator chassis. These currents are induced into the primary winding of the transformer T₇, the secondary of which connects to the grids of audio driver tubes V₁ and V₂. Audio driver tubes V₁ and V₂, Tubes VT-95 (commercial type 2A3), operate as push-pull power amplifiers.

(a) Grid resistors R₁₄ and R₁₅ load the secondary of transformer T₇ to provide proper termination of the incoming audio transmission line from the speech amplifier. Grid bias for tubes V₁ and V₂ is obtained by the drop across cathode resistor R₂₀.

(b) The plates of tubes V₁ and V₂ feed into the primary of driver transformer T₈.

(c) The secondary of transformer T₈ connects to the grids of modulator tubes V₃ and V₄, Tubes VT-218 (commercial type 100TH), and the grids are provided with loading resistors R₁₆ and R₁₇ to present a constant load to tubes V₁ and V₂.

(2) Modulator tubes V₃ and V₄ are connected as a push-pull class B amplifier, in which the normal grid bias is maintained at a point near cutoff for the tubes. At this point the plate current with no audio voltage present will be small, and during speech the plate current will swing up to several times the initial value.

(a) Grid bias for tubes V₃ and V₄ is obtained from potentiometer R₁₂, which is used to adjust the static plate current of these tubes to the normal value of 40 milliamperes.

(b) The plate circuits of tubes V₃ and V₄ are connected to the primary of modulation transformer T₉.

(c) The secondary of modulation transformer T₉ is, during voice operation, connected in series with the high voltage plate power supply of the power amplifier tube V₁₆. Voice impressed upon the microphone will cause a proportional fluctuation in the plate voltage of the power amplifier and cause the output power of the radio transmitter to vary correspondingly, thus creating a modulated radio frequency carrier.

d. Power Supply.—Power for the entire Radio Transmitter BC-610-E is obtained through a-c socket SO₆ from any 117-volt, single-phase, 50-60 cycle source of power.

(1) Filament voltage for the r-f section is supplied by transformer T₄. One winding supplies 6.3 volts to the filaments of tubes V₈, V₉, V₁₀, and V₁₁. Another winding with grounded center tap supplies 5.0 volts to the filament of tube V₁₆. A third winding supplies 5 volts to the filaments of tube V₁₂, Tube VT-145 (commercial type 5Z3), which is the rectifier for the r-f exciter portion of the circuit.

(a) Tube V₁₂ rectifies the power supplied from transformer T₅ on the center chassis.

(b) The rectified power is filtered by capacitors C₁₆ and C₁₇ and by filter choke L₁. Resistor R₄ prevents keying surges, thereby preventing shifts in the signal. Resistor R₁₀ acts as a bleeder resistor to drain off any voltage remaining when the plate power is removed.

(2) Filament power for audio driver tubes V₁ and V₂ is supplied from the secondary of transformer T₁. Filament power for modulator tubes V₃ and V₄ is supplied from the secondary of transformer T₃.

(3) Transformer T₁ also supplies the necessary power to tube V₅, Tube VT-145.

(a) Rectifier tube V₅ supplies plate power through a filter consisting of chokes L₂ and L₃ and capacitors C₂₀ and C₂₁ to audio driver tubes V₁ and V₂. This power supply is operated with the positive side of the d-c potential grounded.

(b) The negative voltage will thus be negative with respect to ground and in addition to supplying plate power for tubes V₁ and V₂ is used as a source of negative bias voltage for the modulator tubes, the class C power amplifier, and the intermediate amplifier tubes. In order to obtain a power source of good regulation, a bleeder consisting of potentiometers R₁₁ and R₁₂ is connected across the output of the filter. The potentiometers may be adjusted for voltages of the correct value.

(4) The high voltage rectifier, located on the lower chassis, employs mercury vapor rectifier tubes V₆ and V₇, Tubes VT-46-A (commercial type 866-A).

(a) Filament supply for tubes V₆ and V₇ is obtained from the secondary of transformer T₂.

(b) Plate power is obtained from the secondary of transformer T₆. The primary of this

transformer is connected to the a-c line and is provided with a tap for raising the voltage applied to the plate of the class C amplifier when c-w transmission is being effected. Higher power output is obtained in this manner.

(c) The rectified high voltage supplied by tubes V_6 and V_7 is filtered by choke L_4 and capacitors C_{19} and C_{23} . The output of the high voltage power supply is shunted by bleeder resistor R_{13} .

e. Control and Metering.—The control and metering circuits are those necessary for the operation, indication of operation, and protection of the equipment.

(1) A-c power entering the equipment passes first through protective fuses FS_1 and FS_2 .

(a) Filament switch SW_1 closes a circuit which applies power to the primaries of transformers T_1 , T_2 , T_3 , and T_4 . Filament voltages are adjusted to the correct values by variable resistor R_{18} on the front panel marked FILAMENT VOLTAGE. This resistor is in series with the primaries of transformers T_2 , T_3 and T_4 . The filament transformers and the bias power transformer are protected by fuses FS_4 , FS_5 , respectively.

(b) When the filaments are turned on, power is also supplied to Speech Amplifier BC-614-E through terminals 1 and 3 on audio power receptacle SO_5 .

(c) Pilot lamp LM_3 illuminates the green jewel on the front panel to indicate when the filaments have been turned on.

(2) EXCITER PLATE POWER switch SW_3 is mounted on the front panel and is used to turn on plate power to the exciter stages only when adjusting the controls on the tuning boxes. Switch SW_3 closes the primary circuit of transformer T_5 which is, in normal operation, closed by one contact on plate power relay RY_1 .

(3) During normal operation both exciter plate power and high voltage plate power are applied by closing switch SW_6 , which is located on the front panel and is marked PLATE POWER.

(4) Switch SW_4 is marked HIGH VOLTAGE PROTECT and, when closed, shorts out resistor R_{19} , which is in series with the primary winding of high voltage transformer T_6 , thereby applying full voltage to tubes V_3 , V_4 , and V_{16} . Switch SW_4 is left open during preliminary adjustment of the transmitter.

(a) For the protection of the operator, switches SW_5 , SW_{13} , SW_{10} , and SW_2 , are connected in series with the coil of relay RY_1 . These switches are door interlocks mounted on the various doors and openings of the transmitter. They prevent the application of high voltage plate power should any of these doors be opened.

(b) For the protection of class C amplifier tube V_{16} and modulator tubes V_3 and V_4 , as well as the components of the high voltage power supply, there is provided an overload relay RY_5 and a locking relay RY_2 . If an extreme surge of current develops in the high voltage power circuit, relay RY_5 closes and thus operates relay RY_2 . Relay RY_2 locks into position until the OVERLOAD RESET switch SW_{12} is pressed. Another contact on relay RY_2 opens the coil circuit to plate power relay RY_1 , thus removing primary power to the high voltage plate power supply.

(5) Relay RY_3 operates in conjunction with C.W.-PHONE switch SW_7 as follows:

(a) Placing C.W.-PHONE switch SW_7 at PHONE closes the cathode circuit to oscillator tube V_8 , connects power to the lower voltage tap on transformer T_6 and closes relay RY_3 , whose contacts apply normal operating voltage to the grids of modulator tubes V_3 and V_4 .

(b) When the switch SW_7 is placed at C.W., the cathode circuit of oscillator tube V_8 is opened so that it may be keyed by the telegraph keys. The power source is then connected to the high voltage primary tap on transformer T_6 , thus providing higher output than in PHONE position. Switch SW_7 at C.W. also releases relay RY_3 , applying cut-off bias to the grids of modulator tubes V_3 and V_4 through resistor R_{34} , shorting out the secondary of Transformer T_9 , to prevent voltage surges during keying.

(6) Plate pilot light LM_4 , with a red indicating jewel, indicates when plate power is applied. Pilot lamps LM_1 and LM_2 illuminate the interior of the upper section in order to facilitate changing of coils.

(7) Filament voltmeter M_3 is connected across the filament of tube V_{16} . When resistor R_{18} has been adjusted so that the meter indicates 5 volts the voltage of ALL filaments will be at their proper value.

(8) Depending on the position of switch SW_8 , meter M_1 indicates:

(a) The plate current of buffer-doubler tube V_9 .

(b) Plate current of intermediate amplifier tubes V_{10} and V_{11} .

(c) Grid current of intermediate amplifier stage V_{10} and V_{11} .

(d) Grid current of the power amplifier stage V_{16} .

Resistors R_{26} , R_{27} , R_{10} , and R_{33} are connected in the circuit to close it when the meter is not applied across that particular circuit.

(9) Meter M_2 indicates the plate current of class C power amplifier tube V_{16} .

19. Antenna Tuning Unit BC-939-A.

a. Mechanical Construction.—Antenna Tuning Unit BC-939-A is constructed on a metal base and metal panel with all of the principal components supported on heavy ceramic insulation. The antenna tuning unit mounts on top of Radio Transmitter BC-610-E and couples the output of the transmitter to the whip antenna. The chief components are two continuously variable loading coils, a coupling coil, an indicating meter, and two fixed vacuum capacitors which may be switched in or out of the circuit (see Figure 15). All controls are located on the front panel. The variable antenna-series-loading coils are controlled by large crank handles coupled to counting devices which indicate directly full and fractional turns of the coils. Connection from the transmitter to the antenna tuning unit is made through a concentric (coaxial) cable; and connection from the antenna tuning unit to Mast Base MP-47 is made by a short flexible lead.

b. Electrical Design.—Radio frequency energy from Radio Transmitter BC-610-E is fed to the primary of the adjustable coupling transformer L_5 through a concentric transmission line (see Figure 19).

(1) The coupling between primary and secondary of coupling coil L_5 is adjustable from the front panel, and determines the amount of power fed from the transmitter to the antenna circuit. With the antenna circuit tuned to resonance, the coupling is adjusted until normal plate current at the power amplifier is obtained, as indicated on the P.A. PLATE meter.

(2) In series with the coupling coil are antenna current meter M_4 , loading coils, and capacitors which are selected by switch SW_9 , and the antenna.

(a) ANTENNA CURRENT meter M_4 indicates the radio frequency current flowing in the

antenna circuit and is a measure of the proper performance of the transmitter.

(b) Antenna loading coil L_6 or L_{44} is used to tune the antenna to resonance. When inductor L_6 or L_{44} is adjusted so that it tunes the antenna to resonance, the antenna circuit absorbs the greatest possible amount of energy from the transmitter. This is noted in practice by an increase in plate current of the power amplifier as inductor L_6 or L_{44} is tuned through the resonance point.

(c) Inductor L_6 is used to tune to frequencies from 2 to 10 megacycles. At frequencies between 6 and 10 megacycles, the antenna reactance decreases so that it becomes difficult to tune by means of inductor L_6 . Over this band of frequencies, capacitor C_{30} is introduced in series with the antenna loading coil by means of switch SW_9 so that adjustment of inductor L_6 becomes less critical. At frequencies between 10 and 18 megacycles inductor L_{44} and series capacitor C_{22} are switched into the series antenna circuit in place of inductor L_6 by means of switch SW_9 .

Note: *The antenna tuning circuit is a very efficient device which, because of the characteristics of the short antenna, causes the antenna voltage to build up to a very high value during operation. READ THE SAFETY NOTICE AT THE BEGINNING OF THIS BOOK AND GUARD AGAINST RECEIVING SEVERE RADIO FREQUENCY BURNS.*

20. Speech Amplifier BC-614-E.

a. Mechanical Construction.—Speech Amplifier BC-614-E is housed in a rectangular sheet steel cabinet which is fastened to a separate base containing rubber shock mountings. The cabinet can be removed from the base by loosening four hasps (two on each side of the cabinet). All of the electrical components are attached either to a panel or to a chassis, both of which form an integral assembly that slides out from the front of the cabinet upon loosening the four thumb screws located in the corners of the panel. The chassis contains all of the tubes and their associated circuits. On the panel are mounted the operating controls and a meter for indicating modulator current. A circuit label is fastened to the bottom of the cabinet for reference in servicing.

b. Voice Circuits.—The voice circuits include tube V_{101} (microphone input amplifier), tube

V_{102} (voltage amplifier with automatically controlled grid bias), tube V_{103} (voltage amplifier and phase inverter), and tube V_{104} (push-pull output tube). Also included is tube V_{105} which is an amplifier and rectifier for the voice limiter circuits (see Figure 23).

(1) Input tube V_{101} , Tube VT-103 (commercial type 6SQ7).

(a) Speech input from the dynamic microphone enters the amplifier at terminal 3 of socket SO_{101} and is impressed across resistor R_{101} , the grid leak for Tube VT-103. After passing through a network composed of resistor R_{102} , R_{103} , and R_{104} as explained in (2) (c) below, the voltage is impressed on the grid of tube V_{101} .

(b) Grid bias for tube V_{101} is obtained by the voltage drop across cathode resistor R_{106} .

(c) The amplified output of the tube is impressed across plate resistor R_{107} and fed through capacitor C_{102} and resistor R_{108} to the arm of gain control R_{111} . This voltage is then fed through capacitor C_{119} to the grid of tube V_{102} .

(2) Tube V_{102} , Tube VT-94 (commercial type 6J5).

(a) This tube is the second voltage amplifier and receives its bias partly through resistor R_{109} from the speech limiting rectifier and partly by the drop across resistor R_{112} in the cathode circuit

(b) With the carbon microphone in use, the input voltage from this microphone enters the speech amplifier through jack J_{102} , passes through transformer T_{101} and resistor R_{110} and is impressed on the arm of carbon microphone gain control R_{142} , from which it is fed to the grid of tube V_{102} .

(c) When it is desired to modulate the transmitter by means of either a local or remote telephone, the voltages from the speech circuits enter the speech amplifier through terminal 3 of socket SO_{102} and pass through resistor R_{105} . The attenuating network consisting of resistors R_{101} , R_{102} , R_{103} , R_{104} , and R_{105} permits this input to be connected into the grid circuit connected to the dynamic Microphone T-50 without upsetting the impedance termination of either one. This network also permits the voltage at the grid of tube V_{101} to be of the proper value in either case.

(d) The amplified speech voltages after passing through tubes V_{101} and V_{102} are impressed across the plate resistor R_{113} and then fed through capacitor C_{103} to the grid of one section of tube V_{103} .

(3) Tube V_{103} , Tube VT-231 (commercial type 6SN7GT), is a dual triode.

(a) By means of one triode section of tube V_{103} the speech voltage is again amplified and impressed across plate resistor R_{117} , whence it is fed through capacitor C_{106} to the grid of tube V_{104} .

(b) A portion of this grid voltage is bypassed across resistor R_{120} as a result of the voltage drop through resistor R_{118} (the grid lead for tube V_{104}). This portion of the voltage is returned to the grid of the other triode section of tube V_{103} . Here it is amplified and impressed across plate resistor R_{116} in proper phase to be fed to the grid of the other section of the tube V_{104} through coupling capacitor C_{105} . True push-pull action is obtained in this manner.

(c) Grid bias of tube V_{103} is obtained by the voltage drop across cathode resistor R_{115} which is shunted by capacitor C_{104} .

(4) Grid bias voltage of tube V_{104} , Tube VT-231, is obtained by the voltage drop across cathode resistor R_{121} shunted by capacitor C_{107} . As explained above, tube V_{104} acts as a push-pull amplifier and its output is delivered to the primary of output transformer T_{102} .

(a) The secondary of transformer T_{102} is connected to a low impedance line through which the amplified speech current is fed to Radio Transmitter BC-610-E through socket SO_{103} .

(b) The relative strength of the output signal as fed to the transmitter is registered on MODULATOR PLATE current meter M_{101} . For normal speech, the meter indicator should be approximately in the center of the scale.

(5) A portion of the voltage on the grid of tube V_{104} is fed back to volume limiter control R_{134} . This control is adjusted so that the proper amount of voltage for correct speech limiting is fed to the grid of tube V_{105} , Tube VT-233 (commercial type 6SR7).

(a) Grid bias for tube V_{105} is obtained by the voltage drop across cathode resistor R_{131} .

(b) The amplified voltage appearing across plate resistor R_{130} is fed through capacitor C_{114} to the primary of transformer T_{104} .

(c) The amplified voltage is applied through the secondary of transformer T_{104} to the plates of the push-pull diodes of tube V_{105} , and the resulting rectified voltage is impressed across resistor R_{133} .

(d) This rectified voltage is both direct and alternating, but the a-c components are substantially neutralized by means of a filter network consisting of resistor R_{132} and capacitor C_{116} . This filter network has the proper time constant to permit the voltage impressed across capacitor C_{116} to vary in proportion to the intensity of the voice signal. However, the voice signal itself is filtered out

(6) Since there is a varying voltage of negative value in proportion to the voice signal across capacitor C_{116} , this voltage is also applied as a variable bias to the grid of tube V_{102} through resistor R_{109} . Tube V_{102} , as employed in this circuit, has variable amplification depending on the variations in grid bias. Hence, an increase in negative grid bias on this tube causes a decrease in amplification. Thus, if the operator talks in a much louder voice than is necessary to completely modulate the transmitter, the amplification of tube V_{102} will decrease due to the action of speech limiting rectifier tube V_{105} reducing the overall gain of the amplifier. The output of the amplifier will then be less than if no limiting were used, which tends to limit over-modulation of the transmitter, and also acts to level off extreme voice peaks.

c. Power Supply.—A-c power is furnished to Speech Amplifier BC-614-E through terminals 1 and 3 on receptacle SO_{103} from Radio Transmitter BC-610-E when its FILAMENT POWER switch is closed.

(1) The a-c power is by-passed by capacitors C_{101} and C_{121} to eliminate r-f feedback from the line.

(a) The a-c power is fed to the primary of transformer T_{103} . One secondary of transformer T_{103} supplies 6.3 volts to filaments of all of the tubes with the exception of the rectifier tube. Filament power for the rectifier tube is supplied by another secondary winding of this transformer which furnishes 5 volts.

(b) Plate power to the rectifier tube V_{107} is supplied by a third secondary on transformer T_{103} .

(2) The rectified output of tube V_{107} , Tube VT-80 (commercial type 80), is filtered by capacitors C_{108} and C_{109} and filter choke CH_{101} .

(a) From the output of this filter the voltage is applied to bleeder resistor R_{125} and to transformer T_{102} to supply plate power to tube V_{104} . The same voltage is also applied to an additional filter network consisting of resistor R_{126} and filter capacitor C_{111} to furnish plate power to tubes V_{103} and V_{106} . After passing through still another filter consisting of resistor R_{127} and filter capacitor

C_{112} , it supplies plate power to tube V_{102} . Two other filters are furnished; one consisting of resistor R_{129} and capacitor C_{115} which supplies tube V_{105} ; the other consisting of resistor R_{128} and filter capacitor C_{113} which supplies voltage to tube V_{101} . The purpose of the cascade filtering is: first, to greatly reduce hum which would be amplified by the sensitive input stages applied to the transmitter; and second, to prevent reaction between cascaded stages.

(b) D-c current for operation of a carbon microphone is provided by utilizing the drop across resistor R_{142} in series with the primary winding of transformer T_{101} and the center tap of high voltage winding of transformer T_{103} . Capacitors C_{110} and C_{120} and resistor R_{124} prevent coupling between the microphone circuit and the plate supply circuit.

(3) Pilot lamp LM_{101} is mounted on the front panel, and lights when the speech amplifier is in operation.

d. Control Circuits.—Operation of the plate power relay in Radio Transmitter BC-610-E is accomplished by closing the circuit between terminals 3 and 4 on receptacle SO_{103} .

e. C-W Sidetone.—Tube V_{106} , Tube VT-231 (commercial type 6SN7GT), is connected as an audio oscillator of the multivibrator type. Plate power is supplied through plate resistors R_{139} and R_{140} . Grid return for one triode section is accomplished through grid resistor R_{135} , and in the other through resistors R_{137} and R_{138} in series. Coupling and feedback of the audio voltage is accomplished by means of coupling capacitors C_{117} and C_{118} . Grid bias for the tube is obtained by the drop across cathode resistor R_{136} . A portion of the audio signal voltage developed by tube V_{106} is applied to the grid of tube V_{108} , Tube VT-94 (commercial type 6J5). The purpose of tube V_{108} is to isolate the multivibrator stage from external keying circuits which would otherwise cause frequency changes in the multivibrator output signal voltage. Grid bias voltage for V_{108} is obtained by the drop across cathode resistor R_{122} . Audio signal voltage for keying is taken from the cathode of tube V_{108} through resistor R_{141} and impressed on terminal 5 of receptacle SO_{102} .

Keying of the sidetone oscillator is accomplished by inserting the plug on cord of Key J-37 into one of the jacks provided in Junction Box JB-70-A. The cathode circuit of tube V_{106} is keyed in parallel with the cathode circuit of the oscillator tube V_8 in Radio Transmitter BC-610-E.

f. Remote Operation.—When remote operation is desired, Telephones EE-8-(*) are connected to the Speech Amplifier BC-614-E through terminal 3 of receptacle SO₁₀₂. This circuit is connected to the input of tube V₁₀₁.

21. Junction Box JB-70-A.

a. Mechanical Construction.—Junction Box JB-70-A is housed in a rectangular sheet steel cabinet which is mounted in the lower left corner of Chest CH-120-A. All electrical parts are attached to the panel and chassis assembly. This assembly slides out from the front of the cabinet upon loosening the four thumb catches located in the corners of the panel

b. Function.—The junction box is a control unit for all the operating components of the transmitting station and a junction point for the interconnecting cords (see figure 21).

(1) **Remote control of power source.**—Power Unit PE-95-(*) may be controlled by the START and STOP buttons of switch SW₂₀₆ located in the center of the front panel. Junction Box JB-70-A contains circuit breaker CB₂₀₀ to protect both the power source and the transmitting equipment in case of severe overload (see figure 11).

(2) **Control of transmitter.**—It is possible to turn the transmitter plate power on or off with the lever key of switch SW₂₀₃ located to the left of the START and STOP buttons. When switch SW₂₀₃ is pushed up to TRANS. ON it closes plate power relay RY₁ in Radio Transmitter BC-610-E, and the keying relay RY₂₀₀, and connects the terminals provided on Junction Box JB-70-A for telephones to remote control switch SW₂₀₂.

(3) **Transmitter keying.**—C-w transmission is made possible by inserting the plug of key J-37 into either jack J₂₀₉ or J₂₀₁. The key operates relay RY₂₀₀ which closes the cathode circuit of the r-f oscillator tube V₈ in Radio Transmitter BC-610-E

(4) **Receiver disabling.**—Radio Receivers BC-312-(*) and BC-342-(*) are equipped with relays capable of opening the antenna circuits of the radio receivers. Relay RY₂₀₀ contains contacts for operating one or two antenna relays of this type during transmission. Relays RY₂₀₀ also contains contacts for shorting out one or two receiver audio circuits, thus preventing microphonic feedback during voice transmission. Switches SW₂₀₀ and SW₂₀₁ (marked RECEIVER CONTROLS) must be switched to AUTO. for receiver protection. (See figure 16 for receiver connections.)

(5) **Remote Telephone Operation.**—If one or two radio receivers and a remote telephone are used in conjunction with the transmitter, the following five additional functions are possible through the use of switch SW₂₀₂ (marked REMOTE CONTROL OF EE-8 on front panel of Junction Box JB-70-A). The five positions and functions of switch SW₂₀₂ are:

(a) **TO BC-312 TELEGRAPH.**—In this position the remote telephone line is connected to keying relay RY₂₀₀ through the transmitter control switch SW₂₀₃. Remote keying is possible when switch SW₂₀₃ is raised to TRANS. ON position. When switch SW₂₀₃ is pressed down to REC. TO EE-8, the output signal of the radio receiver wired to receptacle SO₂₁₀ is heard in the remote telephone

(b) **TO BC-312 TELEPHONE.**—In this position relay RY₂₀₀ may be closed through transmitter control switch SW₂₀₃, and the remote telephone may be connected through switch SW₂₀₃ to the audio input circuit of Speech Amplifier BC-614-E. When the transmitter control switch SW₂₀₃ is raised to TRANS. ON position, relay RY₂₀₀ turns on Radio Transmitter BC-610-E and connects the field telephone to the audio input circuit of the speech amplifier for voice modulation. When switch SW₂₀₃ is pressed down to REC. TO EE-8 the output signal of the radio receiver wired to receptacle SO₂₁₀ is heard in the remote telephone.

(c) **OFF.**—In this position the field telephone circuit is opened and the speech amplifier audio input circuit is grounded.

(d) **TO BC-342 TELEPHONE.**—This position is the same as in (b) above except that when switch SW₂₀₃ is pressed down to REC. TO EE-8, the remote telephone is connected to the output circuit of the radio receiver wired to terminal strip TS₂₀₀.

(e) **TO BC-342 TELEGRAPH.**—This position is the same as in (a) above except that when the remote telephone is connected to the output circuit of the radio receiver wired to terminal strip TS₂₀₀

(6) **Sidetone.**—When switch SW₂₀₅ (marked SIDETONE on front panel of Junction Box JB-70-A) is turned to TO BC-312, the headphone jacks J₂₀₂ and J₂₀₃ are connected into the sidetone circuit. An audio tone of approximately 1000 c.p.s. is heard in the headphones while Key J-37 is pressed. This enables the operator to listen to the

code message being transmitted. Turning switch SW₂₀₅ to TO BC-342 switches the sidetone circuit to jacks J₂₀₄ and J₂₀₅.

(7) **Receiver Output Control.**—When switch SW₂₀₄ (marked RECEIVER OUTPUT on front panel of Junction Box JB-70-A) is at NORMAL a pair of headphones plugged into either jack

J₂₀₂ or J₂₀₃ will connect to the radio receiver wired to receptacle SO₂₁₀. A pair of headphones plugged into either jack J₂₀₄ or J₂₀₅ will connect to the radio receiver wired to terminal strip TS₂₀₀. When switch SW₂₀₄ is thrown to TRANSPOSED, the connections to the headphone jacks will be reversed.

SECTION IV—MAINTENANCE

	<i>Paragraph</i>
Regular Inspection and Service	22
Removal of Equipment	23
Procedure in Case of Equipment Failure	24
Locating Trouble	25
Normal Voltage Readings	26
Cleaning Crystals	27
Access to Components	28
Neutralization	29
Modulation Limiter	30
Use of Analyzer BC-1052-E	31

22. Regular Inspection and Service.—To insure reliable operation of the radio station, it is of the utmost importance that its major components be frequently inspected. *When placed in continuous service, thorough inspection should be made at least once every twenty-four hours.*

a. Components Covered by Separate Instruction Books or Technical Manuals.—Operating personnel should read carefully and note well the chapters entitled "Maintenance" in the instruction books or technical manuals covering Radio Receivers BC-312-(*) and BC-342-(*), the Frequency Meter Set SCR-211-(*), Telephone EE-8-(*), and Power Unit PE-95-(*).

Caution: *The instructions pertaining to the maintenance of Power Unit PE-95-(*) are extremely important, since the radio station is primarily dependent on this source of power.*

b. Outline of Inspection Checks.—[Power Unit PE-95-(*)].

(1) See to it that Power Unit PE-95-(*) is properly inspected and serviced at least once

every twenty-four hours when in continuous service. *Watch oil pressure and engine temperature when in operation.*

(2) Keep an accurate record of all changes of oil, water, and anti-freeze.

(3) Make every effort to change the oil promptly, when the time limit for so doing expires. Neglecting to do so will result in damage to the engine.

c. Outline of Inspection Checks (Major Components).—The major components of Radio Set SCR-399-(*), located within Shelter HO-17-(*), should be checked for proper operating condition as hereinafter outlined and results should be recorded in the station's log every single day that it is in operation.

(1) Check the power cable from trailer to truck. It must be held firmly in place at the trailer and should have sufficient slack to permit the trailer to swing at right angles to the truck. Check safety wire holding cable plugs together. This wire should be firm enough to prevent the plugs from bouncing apart, but should break and

allow the plugs to pull apart should the trailer break away from the truck while in motion.

(2) Check and tighten the clamps holding cable fitting where power cable enters Shelter HO-17-(*).

(3) Make certain that the trailer tail light plug fits firmly into socket at rear of truck.

(4) Check trailer tail and stop lights and replace burnt out lamps when necessary.

(5) Check Telephone EE-8-(*) batteries and replace if necessary.

(6) Check batteries in Frequency Meter Set SCR-211-(*)

(7) Check truck pintle, making certain that trailer eye hook is securely held and make certain that the cotter pin is secure in the pintle. *Never drive without checking condition of the cotter pin*, for should it be missing or break or fall out, the Power Unit PE-95-(*) will break away from the truck when riding over rough roads.

(8) Check and tighten the bolts, wing nuts and clamps holding the following:

(a) Chest CH-89-A to floor.

(b) Heater to floor.

(c) Radio Transmitter BC-610-E to cradle.

(d) Cradle to floor.

(e) Rectifier RA-63-A to floor.

(f) Chest CH-88-A and Chest CH-119-A to wall

(g) Chest CH-109-A to floor.

(h) Antenna Tuning Unit BC-939-A to Radio Transmitter BC-610-E.

(9) Check and tighten turnbuckles holding the following:

(a) Chest CH-121-A to table frame.

(b) Chest CH-120-A to table frame.

(c) Shelter HO-17(*) to truck.

(10) Check for proper contact and proper position, the following plug connections:

(a) BC-312-(*) at PL-114 and at outlet under Junction Box JB-70-A.

(b) BC-342-(*) at PL-114 and at outlet on side of JB-70-A.

(c) Cord CD-763 at outlet under JB-70-A.

(d) Lighting fixture cords at outlet under JB-70-A.

(e) Heater cord at outlet under JB-70-A.

(f) Both ends Cord CD-564 from BC-342-(*) to a-c outlet on side of JB-70-A.

(g) Plugs in rear sockets of BC-610-E.

(h) Plugs in front sockets of BC-614-E.

(i) Plugs at both ends of Cord CD-659.

(j) Plugs at ends of cords from blower, Rectifier RA-63-A, and light fixtures at outlets under JB-70-A

(11) Check for proper quantity of:

(a) Tuning units

(b) Coil units.

(c) Headsets HS-30-(*).

(d) Microphones T-50, T-30-(*), and T-17.

(e) Keys J-37 and J-45.

(f) Trouble lamps.

(g) Fire extinguisher.

(12) Check up on quantity of spare:

(a) Antenna mast sections.

(b) Batteries for EE-8-(*) and SCR-211-(*).

(c) Tubes and pilot lights.

(d) Radio parts.

(e) Electric lamps.

(13) Climb on roof of shelter and tighten all antenna mast sections with two pair of gas pliers. Tape up all antenna joints.

(14) Check condition of and clean all antenna insulators.

(15) Check condition of wires from shelter feed through insulators to Mast Bases MP-48 and tighten.

(16) Check condition of and tighten cables from shelter feed through insulators to CH-121-A and CH-120-A antenna binding posts.

(17) Tighten wing nuts on four Mountings FT-178.

(18) Check Mountings FT-162 of BC-312-(*) and BC-342-(*), making certain that locking wires are in place.

(19) Make sure all thumb screws, holding front panels of BC-312-(*), BC-342-(*), BC-614-E, and JB-70-A in their cabinets, are tightened securely.

(20) Check for proper operation and condition of:

- (a) All Plugs PL-68 and PL-55.
- (b) Both receivers.
- (c) Transmitter and speech amplifier.
- (d) All phones, keys, and microphones.

(21) Never fail to have on hand the following, including tools to be found in Tool Equipment TE-48 (and be certain to replace them if any are missing):

- (a) Soldering iron.
- (b) Rosin core solder.
- (c) Friction tape.
- (d) Gas pliers.
- (e) Cutting pliers.
- (f) Small, medium, and large screw drivers.
- (g) Knife
- (h) Machine oil.

(22) Check condition of spare 12-volt storage battery; add water and recharge if necessary.

d. Cleaning.—The equipment must be kept clean for best service life. At regular intervals (every two to four days), blow dust out of the equipment and clean the antenna tuning inductances with a dry rag or with carbon tetrachloride if available. At greater intervals (every two to three months) check the relay contacts for accumulation of dirt or pitting. The contacts may be cleaned with very fine sandpaper, or with an ignition file. Bear lightly upon the contacts so as not to roughen the surfaces. Insure proper seating of the contacts.

e. Checking Transmitter Performance.—The normal, maximum, and minimum currents and voltages of the principal circuits of Radio Transmitter BC-610-E are listed in the Chart of Performance Characteristics, Section V. These readings serve as a guide to proper performance. No strict interpretation should be made of readings under the heading "normal," as these are subject to some variation. However, the maximum and minimum limits should not be exceeded. A wide variation beyond the extreme limits would indicate improper tuning adjustments or a defective component (usually a fuse, crystal, or tube).

23. Removal of Equipment.—Whenever it becomes necessary to remove any of the major components of Radio Set SCR-399-(*) from within Shelter HO-17-(*), adhere to the following procedure:

- a. Move the truck in such a position as to jack-

knife the Trailer K-52-E and the rear of the truck will become more readily accessible, or if possible, disconnect the trailer.

(1) To remove Chest CH-89-A (seat bench). This requires two men.

(a) Unscrew the 6 wing-head bolts holding it to floor.

(b) Lower the chest from floor of truck to ground, holding by its handles.

(2) To remove Chest CH-88-A (wall). This requires two men.

(a) Remove cotter pins from trunk clasps.

(b) Unclasp all four trunk clasps.

(c) Remove by carrying by its handles.

(3) To remove Chest CH-119-A. This requires two men.

(a) Remove Chest CH-88-A and Chest CH-89-A.

(b) Remove TE-48 and CD-652 from CH-119-A to lighten weight.

(c) Unclasp four trunk clasps.

(d) Slide to door and lower to ground.

(4) To remove Chest CH-121-A. This requires two men. Follow procedure in Paragraph 16 b.

(5) To remove Chest CH-120-A. This requires two to four men.

(a) Disconnect all cords connecting Chest CH-121-A to Chest CH-120-A and close cover of latter.

(b) Disconnect Cord CD-659 from CH-109-A.

(c) Disconnect all cords from bottom of Junction Box JB-70-A.

(d) Disconnect ground straps from bottom of chest.

(e) Disconnect Cord CD-764 from front of Speech Amplifier BC-614-E and remove cord.

(f) Loosen turnbuckles holding Chest CH-120-A to table frame after removing safety wires.

(g) Remove chest from table frame and lower to ground.

(6) To remove Radio Transmitter BC-610-E. This requires four men.

(a) Remove Chest CH-88-A as noted in Paragraph 19 a (1).

(b) Disconnect Cord CD-763 from rear outlet of the transmitter.

(c) Disconnect Cord CD-764 from the metal socket at the rear of the transmitter.

(d) Disconnect antenna lead and ground lead from Antenna Tuning Unit BC-939-A.

(e) Disconnect r-f feeder from the transmitter to the antenna tuning unit.

(f) Disconnect external ground wires which connect the transmitter and the antenna tuning unit to the shelter or other components.

(g) Remove wing nuts holding the antenna tuning unit to top of transmitter.

(h) Remove Antenna Tuning Unit BC-939-A from top of transmitter.

(i) Unscrew the long wrench nuts holding cradle of the transmitter to the floor of the truck.

(j) Move transmitter with its cradle directly toward right wall, to center of truck.

(k) Move the transmitter around into the center aisle and toward the rear of the truck. It will now be necessary to have three of the men on the ground ready to assist in lowering the transmitter from floor of truck to ground.

(l) Grasping the 4 handles firmly, lower directly to ground.

24. Procedure in Case of Equipment Failure.

Caution: Do not change fuses or make repairs with the high voltages on, for under this condition a potential of 2000 to 2500 volts d-c is present on all three decks of the transmitter.

a. Failure of this equipment to operate properly will usually be found to result from the following:

(1) Improperly connected power cable between the Power Unit PE-95-(*) and Shelter HO-17-(*).

(2) Worn, broken, or disconnected cords or plugs.

(3) Defective fuses.

(4) Burned relay contacts due to overloads.

(5) Wires broken from excessive vibration.

(6) Defective tubes.

(7) Inactive (dirty or cracked) crystal.

b. When failure is encountered check the above items before initiating a detailed examination of the component parts of the system.

c. Check fuses at an early stage in shooting trouble. Do not continue to burn out fuses before looking elsewhere to determine the basic source of trouble. (Insertion of an electric lamp in place of a fuse will often prove helpful in tracing source of difficulty if fuses continue to burn out.)

25. Locating Trouble.—There is no substitute for patience, common sense, and thoroughness in overcoming any trouble-shooting problem. In general, the first step is to locate the region where the trouble exists, such as Power Unit PE-95-(*), Radio Transmitter BC-610-E, Speech Amplifier BC-614-E, etc. Next, determine the circuit at fault within this region; and finally by painstaking use of a test meter, a logical process of elimination will lead to the component part causing the trouble. (In an emergency, if no test meter is available, one can be improvised by disconnecting a meter from the equipment.)

THE FOLLOWING SYMPTOMS AND CAUSES MAY ASSIST IN LOCALIZING A
POSSIBLE SOURCE OF TROUBLE IN RADIO SETS SCR-399-(*) AND SCR-499-(*)

<i>Symptom</i>	<i>Likely Cause</i>
a. Power Unit PE-95-(*) refuses to start when the START button is pushed on Junction Box JB-70-A.	(1) START and STOP leads interchanged or disconnected in the trailer terminal board. (2) Discharged battery in the Power Unit PE-95-(*) may operate the relay but refuse to turn over the engine.
b. No filament voltage in Radio Transmitter BC-610-E.	(1) One or all of fuses FS ₁ , FS ₂ , and FS ₄ are burned out. (2) Defective FILAMENT POWER switch. (3) Defective filament resistor, R ₁₈ . (4) Damaged power cord or poor plug contacts. (5) V ₁₃ , V ₁₄ , and V ₁₅ are not in their sockets.
c. No excitation indicated on EXCITATION meter of Radio Transmitter BC-610-E.	(1) Tuning unit improperly installed or missing. (2) BAND SWITCH not set to proper channel. (3) M.O.-XTAL switch on coil box in wrong position. (4) Failure in keying circuits. (5) Fuse FS ₄ burned out. (6) Omission of or defective tubes on exciter deck. (7) Open r-f choke, CH ₈ . (8) EXCITER PLATE POWER switch not turned on for tune-up purposes. (9) Tuning unit not properly tuned.
d. No final amplifier plate current indicated on the P. A. PLATE meter of Radio Transmitter BC-610-E. (Assuming that the necessary P.A. grid current is present.)	(1) "Reset" necessary on overload relay. (2) One or all of fuses FS ₁ , FS ₂ , and FS ₃ burned out. (3) Interlock switches are not all closed due to faulty closing of door if back screen has not been removed. (4) Short circuit in high voltage circuit continually tripping out the overload relay. (5) Poor or no cable connection with Speech Amplifier BC-614-E. (6) Defective rectifier tubes (VT-46-A) or inoperative due to extreme cold. (7) Missing output coil unit L ₇ or improperly installed on jack bar. (8) V ₆ and V ₇ plate caps removed (9) 600 watt heater element used for tuning up on low power is defective or missing. (See R ₁₉ .)
e. Excessive power amplifier plate current indicated on the P.A. PLATE meter of Radio Transmitter BC-610-E.	(1) R-f, choke, CH ₈ , is open. (2) Improper tuning of output circuit i.e. wrong coil unit, L ₇ , failure to use vacuum capacitor C ₂₈ below 2.5 megacycles, etc. (3) Too much antenna coupling. (4) Grid cap on V ₁₆ is loose or removed. (5) No bias voltage due to blown fuse, FS ₅ , or defective rectifier, V ₅ . (6) Voltage breakdown between center tap of L ₇ and the coupling link.
f. Plate voltage of Radio Transmitter BC-610-E final amplifier remains on after being switched off.	(1) Relay RY ₁ , has frozen during a severe overload. (CAUTION: Leave plug out of socket SO ₆ while working on this relay.)
g. Excessive modulator plate current indicated on MOD. PLATE meter.	(1) Fuse FS ₅ blown. (2) Improper adjustment of the bias voltage controlled by the MODULATOR BIAS control on the front panel. (3) Acoustical feedback caused by GAIN control on Speech Amplifier BC-614-E advanced too far. (4) Grid caps of V ₃ and V ₄ are disconnected. (5) Lack of bias voltage because of defective tube V ₅ or blown fuse FS ₅ .
h. No antenna current indicated on ANTENNA CURRENT meter of Antenna Tuning Unit BC-939-A.	(1) Incorrect control settings. (See tuning charts.) (2) Sections of transmitting antenna missing. (3) Coupling set too low in the antenna tuner. (4) Grounding bonds disconnected. (5) Wrong setting of switch on antenna tuning unit.
i. Receiver disabling circuits fail to operate.	(1) SEND-REC. switch on panel of Radio Receiver BC-312-(*) or BC-342-(*) is in the REC. position instead of the SEND position as it should be. (2) The 12-volt battery not connected to Junction Box JB-70-A [when operating without Power Unit PE-95-(*)], or battery switch in wrong position.
j. Microphone "push-to-talk" switch fails to operate.	(1) The 12-volt battery not connected. (2) Poor or broken microphone connection to Speech Amplifier BC-614-E. (3) Faulty switch inside the microphone.

26. Normal Voltage Readings.—The Tube Socket Layout Diagrams Showing Voltages (Figure 22 in Section V) are furnished for the information and guidance of servicing personnel. The values are approximate and will vary slightly with different units and different measuring equipment. The voltage readings represent those to be found in normal operation. The use of these data, combined with a logical circuit analysis, will usually disclose the source of trouble, should improper performance be encountered.

27. Cleaning Crystals.

a. Crystals are mechanically fragile, consequently holders should not be opened for cleaning or inspection unless absolutely certain that crystal is inoperative.

b. Exercise extreme care in handling crystal.

c. When cleaning is necessary, proceed as follows:

- (1) Remove cover screws and cover.
- (2) Remove crystal and electrodes.
- (3) Carefully holding by edges, separately wash crystal and electrodes, using either:
 - (a) Carbon tetrachloride, or
 - (b) Soap and water with a thorough final rinsing in clear water.
 - (c) Dry with a clean, lintless cloth.
- (4) Reassemble crystal and electrodes in holder, still holding by edges.
- (5) Replace cover plate.

28. Access to Components.

a. For access to the various transmitter decks when servicing:

- (1) Disconnect the pair of leads connected to TS₅ on the exciter deck.
- (2) Unscrew four wing bolts holding the cover down and lift straight up to remove.
- (3) Remove seven wing bolts holding the back cover.
- (4) Remove all tubes for safe keeping.
- (5) Lay the transmitter on its right side (side opposite feed-through insulators) to gain access to the bottoms of the exciter chassis, modulator chassis and power supply chassis.

b. For extensive work on the radio frequency stages:

- (1) Disconnect four wires which are tied into a small cable from the terminal strip, TS₁, on the exciter chassis apron.

- (2) Disconnect both leads from the P.A. PLATE meter, M₅.

- (3) Disconnect the twisted pair feeding the coil on the antenna change-over relay, RY₄.

- (4) Disconnect the black, heavy high tension lead from the final tank capacitor mounting strip.

- (5) Remove two plugs, PL₁ and PL₂ from their sockets, SO₁ and SO₂.

- (6) Remove screws and nuts which tie the upper lip of the modulator deck to the lower lip of the r-f deck.

- (7) Lift the r-f deck from the remaining units.

29. Neutralization.

a. Radio Transmitter BC-610-E has been adjusted for neutralization and will not require adjustment in the field, unless the neutralizing capacitor C₁₈ had been tampered with. If this is the case, readjustment may be as follows:

- (1) Install Tuning Unit TU-52 and associated Coil Unit C-390-A.
- (2) Disconnect from transmitter output terminals the two leads to the antenna tuning unit.
- (3) Set FILAMENT POWER switch at ON.

Note: *In this operation high voltage plate power is not applied, so the transmitter control switch on the junction box must be left at TRANS. OFF; and the PLATE POWER switch on the transmitter is set at OFF.*

- (4) Set EXCITATION METER switch at P. A. GRID.

- (5) Set EXCITER PLATE POWER switch at ON.

- (6) Adjust controls of tuning unit to resonance at some frequency near the high frequency end of range.

- (7) Adjust PLATE TUNING wheel slowly through resonance. (If neutralization is faulty, resonance will be indicated by a sharp dip in the reading of the GRID CURRENT meter.)

- (8) Adjust neutralizing capacitor C₁₈, little by little, checking after each adjustment, until rotating the PLATE TUNING wheel through resonance causes only a slight dip in the reading of the GRID CURRENT meter. (When properly neutralized this dip will not exceed 3 ma.)

30. Modulation Limiter.

a. The modulation limiter in Speech Amplifier BC-614-E has been properly set to provide a

minimum of 3 db compression at 100% modulation, and no change in setting is recommended. Readjustment should be made only in the event that MOD. LIMITER control definitely has been tampered with; no adjustment in the field is recommended unless an audio oscillator is available.

b. If necessary, adjustment of the modulation limiter is accomplished as follows:

(1) Disconnect microphone T-50 from its socket on the panel of the speech amplifier.

(2) Connect a 400 cycle audio generator to terminals #1 and #3. (See figure 20 for socket SO₁₀₁ connections.)

(3) Turn on the transmitter and adjust it for phone operation.

(4) Remove the metal plate under the panel marking LIMITER CONTROL on the panel of the speech amplifier. Under this plate you will find the screw adjustment for this control.

(5) Turn the LIMITER CONTROL to the extreme counter clockwise position.

(6) Turn on the 400 cycle generator and adjust its output and the DYNAMIC MIC. 2 gain control for a MODULATOR PLATE meter reading of 225 ma.

(7) Turn the LIMITER CONTROL clockwise until the MODULATOR PLATE meter reads 160 ma.

(8) The modulation limiter has now been adjusted for normal operation. The metal plate should be put back in place and firmly secured. Reconnect microphone T-50 and resume operation.

31. Use of Analyzer BC-1052-E.

a. Analyzer BC-1052-E supplied with Radio Set SCR-399-(*) or SCR-499-(*) can be used for the following purposes:

(1) Voltage measurements (both direct and alternating), from less than a volt to 3,000 volts.

(2) Continuity tests.

(3) Determining values of resistors, zero to 10 megohms.

(4) Direct current measurements, from 0.1 milliamperes to 15 amperes.

b. Directions for setting the analyzer will be found on the chart in its cover.

c. Resistance Measurements.—To test any resistor:

(1) Set the analyzer switches and make test prod connections as indicated in the chart for the range into which the resistor falls.

(2) Short the test prods and adjust the meter for full scale deflecting (ZERO OHMS) by use of OHMS ADJUST knob.

(3) Now touch the test prods to the ends of the resistor, at least one end of which should be disconnected from circuit.

(4) Read the ohms on the OHMS scale, and multiply that reading by the value indicated on the ohms range on the rotary selector switch.

Note: *The OHMS adjustment must be made every time the range switch is changed from one range to another.*

d. Measuring Alternating and Direct Voltage.

Caution: *Whenever approximate voltage, current, or DB level is not known, always begin measurements with highest range to prevent damaging the instrument by an overload.*

(1) Refer to chart for correct settings of controls, switches, jacks, and test prods before making any measurements.

(2) The DECIBEL calibration is for use across 500 ohm lines and loads. The scale is read directly in db.

(3) The OUTPUT jacks are for measuring the voltage or db level of any a-c or audio voltage. Internal circuits are made through a 0.1 mfd isolating capacitor inside the instrument, and in such cases alternating current or audio superimposed on a d-c voltage may be read without harm to the analyzer.

e. High Voltage Measurements.

Caution: *It is extremely dangerous to make this measurement. The high voltage in Radio Transmitter BC-610-E is deadly. Do not make this measurement, except as a last resort, and then always arrange to have someone else present. The recommended procedure for measuring the high voltage is as follows:*

(1) Insulate analyzer well above ground by placing it on dry boards or other insulating material at least one inch thick.

(2) Set analyzer controls to proper positions for measuring 3000 volts as indicated on analyzer chart.

(3) Remove coil unit L₇.

(4) Place red (positive) test lead prod into center jack of the coil unit's jack bar.

(5) Connect black (negative) test lead to any convenient ground on the transmitter frame.

(6) Open right-hand cover door (over tuning units) to open its interlock switch. (This

switch will be used in step (13) to close the circuit.)

(7) Fasten down the interlock switch at the left hand cover door so its circuit is closed.

(8) See that back screen is in place so its interlock is closed.

(9) Arrange the red (positive) test prod and cord so that it is extremely well insulated; it should be carefully supported free and clear from the door and frame of the transmitter and any components.

(10) Stand clear of the red (positive) test lead and see that neither you nor other personnel come in contact with it when voltage is on.

(11) Set PLATE POWER switch of transmitter at ON.

(12) Put your left hand in your pocket.

(13) With your right hand, turn on the high

voltage by pressing the interlock switch at the right-hand cover door.

(14) Read the voltage indication on the analyzer and release the interlock switch.

(15) Set PLATE POWER switch to OFF and remove fastening from left-hand cover interlock when finished.

f. Internal Batteries.—The self-contained batteries of the analyzer consist of two 7½ volt “C” batteries, (Burgess No. 5540 or equivalent) and one 1½ volt heavy duty No. 2 dry cell. These may be replaced by removing the four screws from the front panel. Remove the batteries by loosening the screws holding the brackets which hold the batteries in place. Be sure to observe the polarity when replacing batteries. The 1½ volt battery is held in place by spring clamps. Be sure to cut out a section of the battery paper cover to permit a good connection to the zinc shell.

SECTION V—SUPPLEMENTARY DATA

	<i>Paragraph</i>
Table of Tuning Components	32
Table of Tuning Ranges for Long Wire Antennae	33
Chart of Performance Characteristics	34
Table of Replaceable Parts	35
List of Manufacturers	36

32. Table of Tuning Components.

Tuning Unit	Frequency Range
TU-47	2.0 to 2.5 megacycles
TU-48	2.5 to 3.2 megacycles
TU-49	3.2 to 4.0 megacycles
TU-50	4.0 to 5.0 megacycles
TU-51	5.0 to 6.35 megacycles
TU-52	6.35 to 8.0 megacycles
TU-53	8.0 to 12.0 megacycles
TU-54	12.0 to 18.0 megacycles
Coil Unit	
C-387-B with Capacitor CA-423	2.0 to 2.5 megacycles
C-387-B	2.5 to 3.5 megacycles
C-388-A	3.5 to 4.5 megacycles
C-389-A	4.5 to 5.7 megacycles
C-390-A	5.7 to 8.0 megacycles
C-447	8.0 to 11.0 megacycles
C-448	11.0 to 14.0 megacycles
C-449	14.0 to 18.0 megacycles

33. Table of Tuning Ranges for Long Wire Antennae.

Tuning ranges of long wire antennae when used with
Antenna Tuning Unit BC-939-A

Antenna Lengths	Useful Frequency Range
25 ft.	2 to 10 mc; 15 to 18 mc
35 ft.	2 to 6 mc; 11 to 18 mc
45 ft.	2 to 4 mc; 10 to 18 mc
65 ft.	2 to 3 mc; 9 to 18 mc

34. Chart of Performance Characteristics.

Description	Indicating Meter	Meter Switch Position	Normal	Limits	
				Max.	Min.
Line voltage (A-C)			117 v	125 v	105 v
Filament voltage	FIL. VOLTAGE		5.0 v	5.3 v	4.9 v
Doubler-Buffer plate current	EXCITATION METER	DOUBLER PLATE	35 ma		25 ma
Intermediate amplifier grid current	EXCITATION METER	INT. AMP. GRID	2 ma	8 ma	1 ma
Intermediate amplifier plate current	EXCITATION METER	INT. AMP. PLATE	150 ma	175 ma	
P. A. Grid Current (PLATE POWER OFF)	EXCITATION METER	P. A. GRID	75-100 ma		60 ma
P. A. Grid Current (PLATE POWER ON)	EXCITATION METER	P. A. GRID	65-80 ma		50 ma
P. A. plate current (PHONE)	P. A. PLATE		250 ma	260 ma	200 ma
P. A. plate current (c-w)	P. A. PLATE		290 ma	300 ma	200 ma
Mod. plate current (no mod.)	MOD. PLATE		40 ma	50 ma	35 ma
Mod. plate current (100% mod.)	MOD. PLATE		200 ma		
Power output (voice) (4 MC)			320 watts		210 watts
Power output (c-w)			500 watts		325 watts
Input level to BC-614-E (max. gain) for 100% mod.			46 db. below 1.73 v	40 db. below 1.73 v	
Hum level			40 db. below 100% mod.	35 db. below 100% mod.	

35. Table of Replaceable Parts.

Circuit Symbol	Sig. C. Stock No.	Name and Description of Part	Function	Mfr.	Contractor's Drawing No.
a. Radio Transmitter BC-610-E					
R ₁		Resistor, 33,000 ohm, 10%, ½ watt, insulated carbon, type MB½	Tube V ₈ grid bias	45	G 31369
R ₂		Resistor, 5,600 ohm, 5%, 20 watt, wire wound, type 20VWQ	Tube V ₈ plate voltage stabilizing	48	G 31879
R ₃	3Z6615-38	Resistor, 15,000 ohm, 5%, 20 watt, wire wound, type 20VWQ	Tube V ₈ screen drooping	30, 48	G 31877
R ₄	3Z4607	Resistor, 750 ohm, 10%, 1 watt, insulated carbon, type MB1	Filter network	41, 45	G 31001
R ₅		Resistor, 180 ohm, 10%, 20 watt, wire wound, type EE, special	Protective bias resistor for tubes V ₃ and V ₄	48	G 31602
R ₆	3Z6620-12	Resistor, 20,000 ohm, 10%, 2 watt, carbon	Tube V ₁₀ screen voltage drooping	13	G 30876
R ₇		Resistor. Same as R ₆	Tube V ₁₁ screen voltage drooping		
R ₈		Resistor, 4,700 ohm, 10%, 2 watt, carbon	Tube V ₁₀ and V ₁₁ grid bias	13	G 30880
R ₉	3Z6070-5	Resistor, 700 ohm, 5%, 20 watt, wire wound, type EE	Tube V ₁₆ plate choke shunt	30, 48	G 25652
R ₁₀	3Z6640-16	Resistor, 40,000, 5%, 20 watt, wire wound, type 2R	Exciter power supply bleeder	30	G 31526
R ₁₁	3Z6250-27	Resistor, 2,500 ohm, 5%, 100 watt, variable, type 6½KV	Bias supply bleeder	30	G 25653
R ₁₂	2Z7261	Resistor, 500 ohm, 50 watt, variable, type 0234	Tubes V ₃ and V ₄ bias voltage control	12, 36	G 25702
R ₁₃	3Z6675-15	Resistor, 75,000 ohm, 10%, 200 watt, wire wound, type 10½K	Final amp. H.V. supply bleeder	30	G 27901
R ₁₄	3Z4550	Resistor, 100,000 ohm, 10%, ½ watt, carbon, type MB½	Transformer T ₇ , secondary loading	41, 45	G 31351
R ₁₅		Resistor. Same as R ₁₄	Same as R ₁₄		
R ₁₆	3Z6620-12	Resistor, 20,000 ohm, 10%, 2 watt, carbon	Transformer T ₈ , secondary loading	13	G 30876
R ₁₇		Resistor. Same as R ₁₆	Transformer T ₈ , secondary loading		
R ₁₈	3Z7015-3	Resistor, 15 ohm, 75 watt, variable, type 1107	Fil. voltage control	12, 36	G 25701
R ₁₉	3Z6001F6-2	Resistor, 16 ohm, 600 watt, heater element, type 415-A	Transformer T ₉ , primary voltage drooping	15	G 25651
R ₂₀	3Z6075-16	Resistor, 750 ohm, 5%, 10 watt, wire wound, type CC	Tubes V ₁ and V ₂ bias	30, 48	G 31726
R ₂₁		Resistor, 50 ohm, 10%, ½ watt, carbon, type MB½	Tube V ₁₀ grid parasitic suppressor	41, 45	G 31368
R ₂₂		Resistor. Same as R ₂₁	Tube V ₁₁ grid parasitic suppressor		
R ₂₃		Resistor, 330,000 ohm, 20%, 1 watt, carbon, type MB1	Tube V ₉ grid bias	45	G 31451
R ₂₄		Resistor, 500 ohm, 10%, 10 watt, wire wound, type CC, special	Tube V ₉ cathode bias	48	G 31727
R ₂₅	3Z6650-7	Resistor, 50,000 ohm, 10%, 2 watt, carbon	Tube V ₉ screen drooping	13	G 30877
R ₂₆		Resistor, 0.741 ohms, 0.5%, Temp. Coef. -0.015%, special	Meter shunt (M ₁), 150 ma. range	6	G 25655
R ₂₇		Resistor, 0.351 ohms, 0.5%, Temp. Coef. -0.015%, special	Meter shunt (M ₂), 300 ma. range	6	G 25656
R ₂₈		Resistor, 500 ohm, 10%, 1 watt, wire wound, type MB1	Meter shunt (M ₃), 15 ma. range	45	G 31453
R ₂₉		Resistor. Same as R ₂₈	Meter shunt (M ₄), 150 ma. range		
R ₃₀		Resistor, 25,000 ohm, 10%, 10 watt, wire wound, type CC	Tubes V ₃ and V ₄ grid return	48	G 31729
R ₃₁	3Z4550	Resistor, 100,000 ohm, 20%, ½ watt, carbon, type MB½	Tube V ₈ cathode parasitic suppressor	45	G 15081
R ₃₂		Capacitor, fixed, 0.006 μf, 20%, 600 V. D-C, paper, type 340-24	Tube V ₈ cathode coupling	33	G 26053
C ₁		Same as C ₁	Tube V ₈ screen by-pass		
C ₂		Same as C ₁	Tube V ₈ cathode return by-pass		
C ₃		Same as C ₁	Tube V ₉ screen by-pass		
C ₄		Same as C ₁	Tube V ₈ cathode return by-pass		
C ₅		Same as C ₁	Tube V ₈ plate return by-pass		
C ₆		Capacitor, fixed, 0.002 μf, 20%, 600 V. D-C, paper, type 340-17	Tube V ₁₁ screen by-pass	33	G 26054
C ₇		Same as C ₆	Tube V ₁₀ screen by-pass		
C ₈		Capacitor, fixed, 250 μf, 20%, 1000 V. D-C test, mica, type 0	Tube V ₉ cathode by-pass	33	G 32801
C ₉		Capacitor, 0.05 μf, 20%, 600 V. D-C, dual, oil-filled, paper, type BMM306-140	Tube V ₉ cathode by-pass		
C ₁₀		Same as C ₉ . Part of dual unit	Tube V ₁₀ filament by-pass	33	G 26052
C ₁₁		Capacitor, fixed, 0.002 μf, 5%, 6000 V. D-C, mica, special	Tube V ₁₆ filament by-pass	33	G 26101
C ₁₂	3D9150V-4	Capacitor, variable, 150 μf, max. 7000 V. D-C, air, type 150DD70, special	Tube V ₁₀ plate return by-pass	27	G 29101
C ₁₃		Capacitor, fixed, 150 μf, 20%, 500 V. D-C, mica, type E	Final amp. plate tuning	33	G 32877
C ₁₄	3D9200-35	Capacitor, fixed, 200 μf, 10%, 500 V. D-C, mica, type E	Coupling between tube V ₉ and tubes V ₁₀ and V ₁₁	33	G 32876

C ₁₅	Capacitor, fixed, 0.002 μ f, 20%, 600 V. D-C, mica, type 5	Coupling between tubes V ₁₀ and V ₁₁ and tube V ₁₆	33	G 32826
C ₁₆	Capacitor, fixed, 8.5 μ f, -10 +20%, 1000 V. D-C, oil-filled, dual unit, special	Exciter power supply input filter	26	G 28052
C ₁₇	Same as C ₁₆ . Part of dual unit	Exciter power supply output filter	27	G 26151
C ₁₈	Capacitor, variable, 5.5 μ f max., 7000 V. D-C, air, type 6G70	Final amp. neutralizing	48	G 28051
C ₁₉	Capacitor, fixed, 3 μ f, -10 +40%, 4000 V. D-C, oil-filled	Final amp. H.V. supply filter	2, 26	G 26001
C ₂₀	Capacitor, fixed, 8 μ f, -10 +50%, 600 V. D-C, electrolytic, type 60B5	Bias power supply filter		
C ₂₁	Same as C ₂₀	Bias power supply filter		
C ₂₃	Same as C ₁₉	Final amp. H.V. supply filter	33	G 26051
C ₂₄	Capacitor, fixed, 0.005 μ f, 20%, 1000 V. D-C, oil-filled, special	Tubes V ₁₀ and V ₁₁ plate return by-pass		
C ₂₅	Same as C ₁	Tube V ₆ filament by-pass		
C ₂₆	Same as C ₁	Tube V ₆ plate by-pass	2, 26	G 26002
C ₂₇	Capacitor, fixed, 40 μ f, -10 +65%, 100 V. D-C, elect., special	Tube V ₁ and V ₂ filament by-pass	17	G 28108
C ₂₈	Capacitor CA-423, fixed, 50 μ f, 32,000 V. A-C, vacuum, type VC-50	Final amp. padding	33	G 32851
C ₂₉	Capacitor, fixed, 0.001 μ f, 10%, 2500 V. D-C, low loss mica, type 5	Neutralizing H.V. isolation		
T ₁	Transformer; Prim. 117 V. A-C; Secondary (1) 1000 V. C.T. @ 220 ma., (2) 2.5 V. C.T. @ 5 amps., (3) 5 V. C.T. @ 10 amps., type 10P33	Fil. supply for Tubes V ₁ , V ₂ and V ₅ ; and bias supply voltage	46	G 26253
T ₂	Transformer; Prim. 115-100 V. A-C; Secondary 2.5 V. C.T. @ 10 amps., 6000 V. RMS breakdown test between windings, type 10P34	Fil. supply for tubes V ₆ and V ₇	46	G 26251
T ₃	Transformer; Prim. 115-100 V. A-C; Sec. 5 V. C.T. @ 16 amps., type 10P35	Fil. supply for tubes V ₃ and V ₄	46	G 26255
T ₄	Transformer; Prim. 115-100 V. A-C; Sec. (1) 5 V. C.T. @ 10.5 amps., (2) 6.3 V. C.T. @ 3.5 amps., (3) 5 V. C.T. @ 3.0 amps., type 10P36	Fil. supply for tubes V ₈ , V ₉ , V ₁₀ , V ₁₁ , V ₁₂ and V ₁₆	46	G 26252
T ₅	Transformer; Prim. 125-115 V. A-C; Sec. 870 V. C.T. @ 250 ma., type 10P37	Plate trans. of exciter power supply	46	G 26254
T ₆	Transformer; Prim. 117 V. A-C, tapped to provide sec. voltage of 5000 V. or 4000 V. C.T. @ 500 ma., type 10P43	Plate trans. of high voltage power supply	46	G 28201
T ₇	Transformer; Prim. 500 ohms; Sec. 20,000 ohms C.T., audio type 10A21	Interstage, BC-614 to grids of tubes V ₁ and V ₂	46	G 28151
T ₈	Transformer; Prim. 5,000 ohms; Ratio 1:1.35, 1/2 Prim. to 1/2 Sec., audio, type 10A22	Driver tubes V ₁ and V ₂ plates to mod. tubes V ₃ and V ₄ grids	46	G 28152
T ₉	Transformer; Prim. 16,000 ohms C.T.; Sec. 8330 ohms C.T. @ 250 ma., modulation trans., type 10A38	Mod. tubes V ₃ and V ₄ plates to final amp. high voltage circuit	46	G 28153
L ₁	Reactor, 6 henries, 250 ma., 125 ohm D-C resistance, type 10C13	Exciter power supply filter	46	G 26352
L ₂	Same as L ₁	Bias power supply filter		
L ₃	Same as L ₁	Bias power supply filter		
L ₄	Reactor, 11 henries, 500 ma., 68 ohm D-C resistance, 5000 V. D-C test, type 10C16	Final amp. power supply filter	46	G 26351
L ₇	Coil Unit C-387-B, 32 turn pri., 2 turn sec.	2.0-3.5 mc. final amp. plate coil	8	G 29160
L ₇	Coil Unit C-388-A, 24 turn pri., 2 turn sec.	3.5-4.5 mc. final amp. plate coil	8	G 29161
L ₇	Coil Unit C-389-A, 24 turn pri., 2 turn sec.	4.5-5.7 mc. final amp. plate coil	8	G 29162
L ₇	Coil Unit C-390-A, 18 turn pri., 2 turn sec.	5.7-8.0 mc. final amp. plate coil	8	G 29163
L ₇	Coil Unit C-447, 14 turn pri., 2 turn sec.	8.0-11.0 mc. final amp. plate coil	8	G 29164
L ₇	Coil Unit C-448, 12 turn pri., 1 turn sec.	11.0-14.0 mc. final amp. plate coil	8	G 29165
L ₇	Coil Unit C-449, 8 turn pri., 1 turn sec.	14.0-18.0 mc. final amp. plate coil	8	G 29166

The word Special indicates part made for, or by the Contractor.

35. Table of Replaceable Parts—(Continued)

Circuit Symbol	Sig. C Stock No.	Name and Description of Part	Function	Mfr.	Contractor's Drawing No.
Radio Transmitter BC-610-E (Continued)					
CH ₁	3C363	R-F choke, 1 mh., 10%, 20 ohm D-C resistance	Tube V ₈ grid return r-f choke	22	G 26302
CH ₂		Same as CH ₁	Tube V ₈ cathode return r-f choke		
CH ₃		R-F choke, 2.5 mh., 5%, 25 ohm D-C resistance	Tube V ₈ plate return r-f choke	22	G 26303
CH ₄	3C562	R-F choke, 2.5 mh., 10%, 8.5 ohms D-C resistance	Tube V ₁₆ plate return r-f choke	39	G 26201
CH ₅		Same as CH ₁	Tube V ₆ plate return r-f choke		
CH ₆		Same as CH ₁	Tubes V ₁₀ and V ₁₁ plate return r-f choke		
CH ₇		Same as CH ₁	Tubes V ₁₀ and V ₁₁ grid return r-f choke		
CH ₈		Same as CH ₁	Tube V ₁₆ grid return r-f choke		
CH ₉	3C550	R-F choke, 10 mh., 10%, 42 ohm D-C resistance, 500 ma. max. current	Tube V ₈ cathode return r-f choke	22	G 26301
RY ₁		Relay, DPST, 117 V. A-C, type 1154	Plate power ON-OFF	29	G 29053
RY ₂	2Z7717.5	Relay, DPDT, 117 V. A-C, type G32423	Overload protection in H.V. supply	21	G 25602
RY ₃	2Z7717.2	Relay, DPDT, 117 V. A-C, type 400	PHONE-CW switching	1	G 27801
RY ₄	2Z7717.3	Relay, DPDT, 117 V. A-C, type 1702 MX	Antenna shorting	29	G 25601
RY ₅	2Z7717.4	Relay, DPST, 700 ma. D-C, type G32422	Overload protection in H.V. supply	21	G 25603
SW ₁	3Z9851	Switch, SPST, toggle, type P & S #1311	Fil. ON-OFF	37	G 26402
SW ₂	3Z9812-2	Switch, SPST, interlock, type 3592D	Trans. top cover safety	14	G 26405
SW ₃		Switch, DPST, bakelite, type P & S #1312	Exciter plate power "ON-OFF"	37	G 26407
SW ₄		Switch, SPST, toggle, type P & S #1311 special	High voltage protection switch	37	G 26403
SW ₅	3Z9812-2	Switch, SPST, interlock, type C & H 1796	Trans. rear cover safety	24	G 26409
SW ₆		Same as SW ₁	Trans. plate power "ON-OFF"		
SW ₇	3Z9854-14	Switch, 4PDT, toggle, type 3885K1	PHONE-CW switching	14	G 26401
SW ₈		Switch assembly, 2 section, 4 position	Meter switch (M ₁)	35	G 26411
SW ₁₀		Same as SW ₂	Trans. top cover safety		
SW ₁₁	2C6500A/S1	Switch assembly, 4 section, 3 position, isolantite wafers	Exciter tuning unit switching	35	G 28251
SW ₁₂	3Z79824-274	Switch, SPST momentary push button, type PS-3	Overload relay reset	48	G 26410
SW ₁₃		Same as SW ₂	Tuning unit compartment		
M ₁		Meter, multiple scale milliammeter, special, type DO-54	Tube V ₁₆ , V ₁₀ , V ₁₁ and V ₉ current indicator	19	G 27003
M ₂	3F950-20	Meter, milliammeter, 0-500 ma. D-C, type DO-53	Tube V ₁₆ plate current indicator	19	G 27002
M ₃	3F8010-8	Meter, voltmeter, 0-10 V. A-C, type DO-53	Tube V ₁₆ fil. voltage indicator	19	G 27004
SO ₁	2Z8639.1	Socket, 6 contact, female, type S-406-AB	Socket on mod. chassis for plug PL ₁	28	G 25302
SO ₂		Same as SO ₁	Socket on mod. chassis for plug PL ₂		
SO ₃		Socket, 8 contact, female, type S-408-AB	Socket on mod. chassis for plug PL ₃	28	G 25304
SO ₄		Same as SO ₁	Socket on mod. chassis for plug PL ₄		
SO ₅		Socket, amphenol connector	Speech amp. input connection BC-610	4	G 27701
SO ₆	2Z3099-1	Socket, male (twist lock type) 20 amp., 250 V., type 3808	110 V. A-C power input connection on BC-610		
SO ₇		Socket, 12 terminal, bakelite, special	Channel 1 tuning unit socket	25	G 25303
SO ₈	2Z8639-5	Same as SO ₇	Channel 2 tuning unit socket	28	G 23703
SO ₉		Same as SO ₇	Channel 3 tuning unit socket		
SO ₁₁		Socket, 8 terminal, female, type S-408-AB modified	Socket on upper control panel for plug PL ₁₁	28	G 25313

RADIO SETS SCR-399-A & SCR-499-A

PL ₁	2Z7228-25	Plug, 6 contact, male, type P-406-LAB	28	G 25318
PL ₂		Same as PL ₁		
PL ₃		Plug, 8 contact, male, type P-408-LAB	28	G 25319
PL ₄		Plug, 6 contact, male, type P-406-LAB	28	G 25318
PL ₁₁		Same as PL ₃		
TS ₁	2Z9412	Terminal strip, 12 terminal, special	28	G 26955
TS ₂		Same as TS ₁		
TS ₃	2Z9408.1	Terminal block, 8 terminal, special		
TS ₄	2Z0402	Terminal strip, standard 2 terminal, type 1720	28	G 27253
TS ₅	2Z9402.1	Tip jack strip, standard 2 jack, type 1490	10	G 27256
FS ₁	3Z2025	Fuse, 25 amp., 125 V., type 4325	10	G 27252
FS ₂		Same as FS ₁	16	G 25953
FS ₃	3Z2020	Fuse, 20 amp., 125 V.	19	G 25954
FS ₄		Fuse, 5 amp., 250 V., type 1358		
FS ₅	3Z603.2	Fuse, 3 amp., 125 V., type 1043	31	G 25963
LM ₁	2Z5927	Lamp, 6.3 V., 250 ma., bayonet base, type 44	31	G 25962
LM ₂		Same as LM ₁	19	G 25952
LM ₃	2Z5886-1	Lamp, 120 V., 6 W., candelabra base, type S6, clear	19	G 25951
LM ₄		Same as LM ₃		
V ₁	2T95	Tube VT-95, triode	38, 47	G 30051
V ₂		Same as V ₁		
V ₃	2T218	Tube VT-218, triode	17	G 30058
V ₄		Same as V ₃		
V ₅	2T145	Tube VT-145, duo-diode	34, 47	G 30057
V ₆	2T46A	Tube VT-46-A, diode	34, 38	G 30052
V ₇		Same as V ₆		
V ₈	2T107	Tube VT-107, pentode	34, 47	G 30054
V ₈ *	2T107A	Tube VT-107-A, pentode	34, 47	G 30054
V ₉	2T115	Tube VT-115, pentode	38, 47	G 30055
V ₉ *	2T115A	Tube VT-115-A, pentode	38, 47	G 30055
V ₁₀	2T100	Tube VT-100, pentode	34, 47	G 30053
V ₁₁		Same as V ₁₀		
V ₁₂		Same as V ₆		
V ₁₃	2T139	Tube VT-139, diode gas filled	38, 47	G 30056
V ₁₄		Same as V ₁₃		
V ₁₅		Same as V ₁₃		
V ₁₆	2T220	Tube VT-220, triode	17	G 30059

b. Tuning Units for Radio Transmitter BC-610-E
(1) Tuning Unit TU-47 (2.0 to 2.5 mc.)

C ₃₁	3D9140V-7	Variable capacitor, air, 140 μμf max.	7	G 26153
C ₃₂	3D9140V-7	Variable capacitor, air, 140 μμf max.	7	G 26153
C ₃₄	3D9190V	Variable capacitor, air, 190 μμf max.	7	G 26155

*Alternate glass envelope type tubes
The word Special indicates part made for, or by the Contractor.

35. Table of Replaceable Parts—(Continued)

Circuit Symbol	Sig. C. Stock No.	Name and Description of Part	Function	Mfr.	Contractor's Drawing No.
b. Tuning Units for Radio Transmitter BC-610-E (Continued)					
C ₃₆	3D140-1	Fixed capacitor, 155 μf 2% ceramic, Temp. Coef. -0.00015, 500 V. D-C, special	Master Osc. padding capacitor	9, 18	G 26102
C ₄₂	3D9040-10	Fixed capacitor, 40 μf 5% ceramic, Temp. Coef. zero, 500 V. D-C, special	Grid coupling capacitor	9, 18	G 26106
C ₄₄	3D9250-20	Fixed capacitor, 250 μf 10% mica, 500 V. D-C, type 0	Cathode coupling capacitor	33	G 32801
C ₄₇	3C1090	Fixed capacitor, 75 μf 20% mica, 500 V. D-C	Crystal coupling capacitor	7	G 32802
L ₈	3C1090	R-F coil, 96 μh , tapped, special	Master Osc. inductor	7	G 26215
L ₁₄	3C1090-6	R-F coil, 28.8 μh , single winding, special	Crystal Osc. inductor	7	G 26202
L ₂₀	3C1090-12	R-F coil, 36.3 μh , single winding, special	Buffer-Doubler inductor	7	G 26208
L ₂₆	3C1090-12	R-F coil, 36.3 μh , single winding, special	Int. Amp. inductor	7	G 26208
PL ₁₀	2Z7228-10.1	Plug, special, 12 prong, bakelite	Tuning unit base and terminal prongs	28	G 26954
SW ₁₅	3Z9858-3	Switch, DPDT, toggle	MO-XTAL	14	G 26406
(2) Tuning Unit TU-48 (2.5 to 3.2 mc.)					
C ₃₁	3D9140V-7	Variable capacitor, air, 140 μf max.	Master Osc. tuning capacitor	7	G 26153
C ₃₃	3D9100V-8	Variable capacitor, air, 100 μf max.	Buffer-Doubler tuning capacitor	7	G 26152
C ₃₅	3D9100V-9	Variable capacitor, air, 100 μf	Int. Amp. tuning capacitor	7	G 26154
C ₃₇	3D9155-1	Fixed capacitor, 160 μf 2% ceramic, Temp. Coef. -0.00015, 500 V. D-C, special	Master Osc. padding capacitor	9, 18	G 26107
C ₄₃	3D9050-61	Fixed capacitor, 50 μf 5% ceramic, Temp. Coef. zero, 500 V. D-C, special	Grid coupling capacitor	9, 18	G 26115
C ₄₅	3D9400-16	Fixed capacitor, 400 μf 10% mica, 500 V. D-C	Cathode coupling capacitor	7	G 32803
L ₉	3C1090-1	R-F coil, 55.5 μh , tapped, special	Master Osc. inductor	7	G 26214
L ₁₅	3C1090-7	R-F coil, 12.0 μh , single winding, special	Crystal Osc. inductor	7	G 26203
L ₂₁	3C1090-13	R-F coil, 30.8 μh , single winding, special	Buffer-Doubler inductor	7	G 26209
L ₂₇	3C1090-13	R-F coil, 30.8 μh , single winding, special	Int. Amp. inductor	7	G 26209
PL ₁₀	2Z7228-10.1	Plug, special, 12 prong, bakelite	Tuning unit base and terminal prongs	22	G 26954
SW ₁₅	3Z9858-3	Switch, DPDT, toggle	MO-XTAL switching	14	G 26406
(3) Tuning Unit TU-49 (3.2 to 4.0 mc.)					
C ₃₁	3D9140V-7	Variable capacitor, air, 140 μf max.	Master Osc. tuning capacitor	7	G 26153
C ₃₃	3D9100V-8	Variable capacitor, air, 100 μf max.	Buffer-Doubler tuning capacitor	7	G 26152
C ₃₅	3D9100V-9	Variable capacitor, air, 100 μf max.	Int. Amp. tuning capacitor	7	G 26154
C ₃₈	3D9135-2	Fixed capacitor, 135 μf 2% ceramic, Temp. Coef. -0.00015, 500 V. D-C, special	Master Osc. padding capacitor	9, 18	G 26110
C ₄₃	3D9050-61	Fixed capacitor, 50 μf 5% ceramic, Temp. Coef. -0.00015, 500 V. D-C, special	Grid coupling capacitor	9, 18	G 26104
L ₁₀	3C1090-2	R-F coil, 41.0 μh , tapped, special	Master Osc. inductor	7	G 26216
L ₁₆	3C1090-8	R-F coil, 9.2 μh , single winding, special	Crystal inductor	7	G 26204
L ₂₂	3C1090-14	R-F coil, 20.6 μh , single winding, special	Buffer-Doubler inductor	7	G 26210
L ₂₈	3C1090-14	R-F coil, 20.6 μh , single winding, special	Int. Amp. inductor	7	G 26210
PL ₁₀	2Z7228-10.1	Plug, special, 12 prong, bakelite	Tuning unit base and terminal prong	28	G 26954
SW ₁₅	3Z9858-3	Switch, DPDT, toggle	MO-XTAL switching	14	G 26406

RADIO SETS SCR-399-A & SCR-499-A

(4) Tuning Unit TU-50 (4.0 to 5.0 mc.)

C ₃₁	3D9140V-7	Variable capacitor, air, 140 $\mu\mu\text{f}$ max.	Master Osc. tuning capacitor	7	G 26153
C ₃₃	3D9100V-8	Variable capacitor, air, 100 $\mu\mu\text{f}$ max.	Buffer-Doubler tuning capacitor	7	G 26152
C ₃₅	3D9100V-9	Variable capacitor, air, 100 $\mu\mu\text{f}$ max.	Int. Amp. tuning capacitor	7	G 26154
C ₃₉	3D9170-1	Fixed capacitor, 170 $\mu\mu\text{f}$ 2% ceramic, Temp. Coef. -0.00015, 500 V. D-C, special	Master Osc. padding capacitor	9, 18	G 26103
C ₄₃	3D9050-61	Fixed capacitor, 50 $\mu\mu\text{f}$ 5% ceramic, Temp. Coef. zero, 500 V. D-C special	Grid coupling capacitor	9, 18	G 26115
C ₄₆	3D9100-67	Fixed capacitor, 100 $\mu\mu\text{f}$ 10% mica, 500 V. D-C	Cathode coupling capacitor	83	G 26116
L ₁₁	3C1090-3	R-F coil, 21.4 μh , tapped, special	Master Osc. inductor	7	G 26217
L ₁₇	3C1090-9	R-F coil, 66.0 μh , single winding, special	Crystal Osc. inductor	7	G 26205
L ₂₃	3C1090-15	R-F coil, 12.6 μh , single winding, special	Buffer-Doubler inductor	7	G 26211
L ₂₉	3C1090-15	R-F coil, 12.6 μh , single winding, special	Int. Amp. inductor	7	G 26211
PL ₁₀	2Z7228-10.1	Plug, special, 10 prong, bakelite	Tuning unit base and terminal prongs	28	G 26954
SW ₁₅	3Z9858-3	Switch, DPDT, toggle	MO-XTAL switching	14	G 26406

(5) Tuning Unit TU-51 (5.0 to 6.35 mc.)

C ₃₁	3D9140V-7	Variable capacitor, air, 140 $\mu\mu\text{f}$ max.	Master Osc. tuning capacitor	7	G 26153
C ₃₃	3D9100V-8	Variable capacitor, air, 100 $\mu\mu\text{f}$ max.	Buffer-Doubler tuning capacitor	7	G 26152
C ₃₅	3D9100V-9	Variable capacitor, air, 100 $\mu\mu\text{f}$ max.	Int. Amp. tuning capacitor	7	G 26154
C ₄₀	3D9160	Fixed capacitor, 160 $\mu\mu\text{f}$ 2% ceramic, Temp. Coef. -0.00015, 500 V. D-C, special	Master Osc. padding capacitor	9, 18	G 26107
C ₄₂	3D9040-10	Fixed capacitor, 40 $\mu\mu\text{f}$ 5% ceramic, Temp. Coef. zero, 500 V. D-C, special	Grid coupling capacitor	9, 18	G 26106
C ₄₅	3D9400-16	Fixed capacitor, 400 $\mu\mu\text{f}$ 20% mica, 500 V. D-C	Cathode coupling capacitor	7	G 32803
L ₁₂	3C1090-4	R-F coil, 14.1 μh , tapped, special	Master Osc. inductor	7	G 26218
L ₁₈	3C1090-10	R-F coil, 22.8 μh , single winding, special	Crystal Osc. inductor	7	G 26206
L ₂₄	3C1090-16	R-F coil, 12.6 μh , single winding, special	Buffer-Doubler inductor	7	G 26212
L ₃₀	3C1090-16	R-F coil, 12.6 μh , single winding, special	Int. Amp. inductor	7	G 26212
PL ₁₀	2Z7228-10.1	Plug, special, 10 prong, bakelite	Tuning unit base and terminal prongs	28	G 26954
SW ₁₅	3Z9858-3	Switch, DPDT, toggle	MO-XTAL switching	14	G 26406

(6) Tuning Unit TU-52 (6.35 to 8.0 mc.)

C ₃₁	3D9140V-7	Variable capacitor, air, 140 $\mu\mu\text{f}$ max.	Master Osc. tuning capacitor	7	G 26153
C ₃₃	3D9100V-8	Variable capacitor, air, 100 $\mu\mu\text{f}$ max.	Buffer-Doubler tuning capacitor	7	G 26152
C ₃₅	3D9100V-9	Variable capacitor, air, 100 $\mu\mu\text{f}$ max.	Int. Amp. tuning capacitor	7	G 26154
C ₄₁	3D9185-1	Fixed capacitor, 185 $\mu\mu\text{f}$ 5% ceramic, Temp. Coef. -0.00015, 500 V. D-C, special	Master Osc. padding capacitor	9, 18	G 26105
C ₄₂	3D9040-10	Fixed capacitor, 40 $\mu\mu\text{f}$ 2% ceramic, Temp. Coef. -0.00015, 500 V. D-C, special	Grid coupling capacitor	9, 18	G 26106
C ₄₅	3D9400-16	Fixed capacitor, 400 $\mu\mu\text{f}$ 20% mica, 500 V. D-C	Cathode coupling capacitor	7	G 32803
L ₁₃	3C1090-5	R-F coil, 8.1 μh , tapped, special	Master Osc. inductor	7	G 26219
L ₁₉	3C1090-11	R-F coil, 18.0 μh , single winding, special	Crystal Osc. inductor	7	G 26207
L ₂₅	3C1090-17	R-F coil, 5.66 μh , single winding, special	Buffer-Doubler inductor	7	G 26213
L ₃₁	3C1090-17	R-F coil, 5.66 μh , single winding, special	Int. Amp. inductor	7	G 26213
PL ₁₀	2Z7228-10.1	Plug, special, 10 prong, bakelite	Tuning unit base and terminal prongs	28	G 26954
SW ₁₅	3Z9858-3	Switch, DPDT, toggle	MO-XTAL switching	14	G 26406

The word Special indicates part made for, or by the Contractor.

35. Table of Replaceable Parts—(Continued)

Circuit Symbol	Sig. C. Stock No.	Name and Description of Part	Function	Mfr.	Contractor's Drawing No.
(7) Tuning Unit TU-53 (8.0 to 12.0 mc.)					
R ₂₉		Resistor, 30,000 ohms, 10%, ½ watt, carbon	Master oscillator grid leak	45	G 31353
R ₃₀		Resistor, 30,000 ohms, 10%, ½ watt, carbon	Crystal oscillator grid leak	45	G 31353
C ₃₁	3D9140V-7	Capacitor, variable, 140 μμf max., air	Master Osc. tuning capacitor	7	G 26153
C ₃₂	3D9190V	Capacitor, variable, 140 μμf max., air	Buffer-Doubler tuning capacitor	7	G 26153
C ₃₄	3D9050-61	Fixed capacitor, 50 μμf 5% ceramic, Temp. Coef. zero, 500 V. D-C, special	Int. Amp. tuning capacitor	7	G 26155
C ₄₄	3D9250-20	Capacitor, fixed, 250 μμf 20%, 500 V. D-C, mica, type 0	Grid coupling capacitor	9, 18	G 26115
C ₄₈		Capacitor, fixed, 65 μμf 2%, 500 V. D-C, ceramic, Temp. Coef. -0.00015, special	Cathode coupling capacitor	33	G 32801
L ₃₂		R-F coil, 7.5 μh tapped, special	Master Osc. padding capacitor	9, 18	G 26111
L ₃₃		R-F coil, 2.56 μh single winding, special	Master Osc. inductor	7	G 26234
L ₃₄		R-F coil, 2.56 μh single winding, special	Buffer-Doubler inductor	7	G 26235
L ₄₁		R-F coil, 8.0 μh single winding, special	Int. Amp. inductor	7	G 26238
PL ₁₀	2Z7228-10.1	Plug, 12 prong, bakelite, special	Crystal Osc. inductor	7	G 26238
SW ₁₅	3Z9858-3	Switch, DPDT, toggle	Tuning unit base and terminal prongs	28	G 26954
			MO-XTAL switching	14	G 26406
(8) Tuning Unit TU-54 (12.0 to 18.0 mc.)					
R ₃₁		Resistor, 30,000 ohms, 10%, ½ watt, carbon, type MB½	Crystal oscillator grid resistor	45	G 31353
R ₃₂		Resistor, 30,000 ohms 10%, ½ watt, carbon, type MB½	Master oscillator grid resistor	45	G 31353
C ₃₁	3D9140V-7	Capacitor, variable, 140 μμf max., air	Master Osc. tuning capacitor	7	G 26153
C ₃₂	3D9140V-7	Capacitor, variable, 140 μμf max., air	Buffer-Doubler tuning capacitor	7	G 26153
C ₃₄	3D9190V	Capacitor, variable, 190 μμf max., air	Int. Amp. tuning capacitor	7	G 26156
C ₄₉		Capacitor, fixed, 65 μμf 2%, 500 V. D-C, ceramic, Temp. Coef. -0.00015, special	Master Osc. padding capacitor	9, 18	G 26111
C ₆₀	3D9075-7	Capacitor, fixed, 75 μμf 5%, 500 V. D-C, ceramic, Temp. Coef. -0.00075, special	Grid coupling capacitor	9, 18	G 26110
L ₃₅		R-F coil, 12.7 μh tapped, special	Master Osc. inductor	7	G 26236
L ₃₆		R-F coil, 4.48 μh tapped, special	Buffer-Doubler inductor	7	G 26237
L ₃₇		R-F coil, 1.15 μh tapped, special	Int. Amp. inductor	7	G 26237
L ₄₂		R-F coil, 14.2 μh single winding, special	Crystal Osc. inductor	7	G 26221
PL ₁₀	2Z7228-10.1	Plug, 12 prong, bakelite, special	Tuning unit base and terminal base	28	G 26954
SW ₁₅	3Z9858-3	Switch, DPDT, toggle	"MO-XTAL" switching	14	G 26406
c. Antenna Tuning Unit BC-939-A					
C ₂₂	3D9012-32	Capacitor, fixed, 12 μμf, -1 + ½%, 20,000 V. D-C, vacuum, type VC-12	Impedance matching capacitor	17	G 28102
C ₃₀	3D423	Capacitor CA-423, fixed, 50 μμf, 32,000 V. A-C, vacuum, type VC-50	Impedance matching capacitor	17	G 28103
L ₁		Replacement coupling inductor assembly, special	Coupling inductor	8	G 28926
L ₆	3C302B-2	R-F coil, variable inductance, special	Low frequency loading	8	G 29167
L ₁₄		Replacement high freq. loading inductor, special	High frequency loading	8	G 28927
SW _{5.1}		Switch assembly, front section, isolantite	Inductor selector	8	G 29520
SW _{5.2}		Switch assembly, rear section, isolantite	Inductor selector	8	G 29521
M ₁	3F1015-18	Meter, ammeter, 0-15 amp., R-F, type DO-54	Antenna current indicator	19	G 27006

d. Speech Amplifier BC-614-E

R ₁₀₁	3Z6801-16	Resistor, 1 megohm, 20%, 1/2 watt, carbon, type MB1/2	Gain dividing component at grid of tube V ₁₀₁	45	G 31360
R ₁₀₂		Same as R ₁₀₁	Gain dividing component at grid of tube V ₁₀₁		
R ₁₀₃	3Z4548	Resistor, 200,000 ohm, 10%, 1/2 watt, carbon, type MB1/2	Gain dividing component at grid of tube V ₁₀₁	45	G 31362
R ₁₀₄	3Z6010-18	Resistor, 100 ohm, 10%, 1/2 watt, carbon, type MB1/2	Gain dividing component at grid of tube V ₁₀₁	45	G 31354
R ₁₀₅	3Z4525	Resistor, 1,000 ohm, 10%, 1/2 watt, carbon, type MB1/2	Gain dividing component at grid of tube V ₁₀₁	45	G 31359
R ₁₀₆	3Z4525	Resistor, 1,000 ohm, 10%, 1/2 watt, carbon, type MB1/2	Cathode bias for tube V ₁₀₁	45	G 31359
R ₁₀₇	3Z4550	Resistor, 100,000 ohm, 10%, 1/2 watt, carbon, type MB1/2	Plate resistor for tube V ₁₀₁	45	G 31359
R ₁₀₈		Same as R ₁₀₃	Mixer isolating resistor	41, 45	G 31351
R ₁₀₉	3Z4533	Resistor, 500,000 ohm, 10%, 1/2 watt, carbon, type MB1/2	Mod. limiter isolating resistor	45	G 31366
R ₁₁₀	3Z4562	Resistor, 250,000 ohm, 10%, 1/2 watt, carbon, type MB1/2	Mixer isolating resistor	45	G 31358
R ₁₁₁	2Z7298-3	Resistor, variable, 1 megohm, 20%, special	Low level gain control	45	G 34777
R ₁₁₂	2Z7298-3	Same as R ₁₀₆	Cathode bias for tube V ₁₀₂		
R ₁₁₃		Same as R ₁₀₇	Plate resistor for tube V ₁₀₂		
R ₁₁₄		Same as R ₁₁₀	Grid resistor for tube V ₁₀₃		
R ₁₁₅	3Z6050-47	Resistor, 500 ohm, 10%, 1 watt, type MB1	Cathode bias for tube V ₁₀₃	45	G 81458
R ₁₁₆		Same as R ₁₀₇	Plate resistor for tube V ₁₀₃		
R ₁₁₇		Same as R ₁₀₇	Plate resistor for tube V ₁₀₃		
R ₁₁₈		Same as R ₁₁₀	Grid resistor for tube V ₁₀₄		
R ₁₁₉		Same as R ₁₁₆	Grid resistor for tube V ₁₀₄		
R ₁₂₀		Same as R ₁₁₀	Grid resistor for tube V ₁₀₅		
R ₁₂₁		Same as R ₁₁₅	Cathode bias for tube V ₁₀₄		
R ₁₂₂		Resistor, 2,000 ohm, 10%, 1/2 watt, carbon, type MB1/2	Cathode bias for tube V ₁₀₅	45	G 31367
R ₁₂₃		Same as R ₁₁₁	Carbon mic. gain control		
R ₁₂₄	3Z6030-11	Resistor, 300 ohm, 10%, 1 watt, carbon, type MB1	Mic. voltage filter	45	G 81452
R ₁₂₅	3Z6675-10	Resistor, 75,000 ohm, 10%, 2 watt, carbon	Power supply bleeder	13	G 30878
R ₁₂₆	3Z6620-12	Resistor, 20,000 ohm, 10%, 2 watt, carbon	Audio decoupling for tube V ₁₀₃	13	G 30876
R ₁₂₇		Resistor, 50,000 ohm, 10%, 1 watt, carbon, type A1	Audio decoupling for tube V ₁₀₂	13	G 81454
R ₁₂₈		Same as R ₁₂₇	Audio decoupling for tube V ₁₀₁		
R ₁₂₉	3Z6620-46	Resistor, 20,000 ohm, 10%, 1/2 watt, carbon, type A1/2	Audio decoupling for tube V ₁₀₅	13	G 31361
R ₁₃₀	3Z4531	Resistor, 50,000 ohm, 10%, 1/2 watt, carbon, type A1/2	Plate resistor for tube V ₁₀₅	13	G 31365
R ₁₃₁		Same as R ₁₀₆	Cathode bias for tube V ₁₀₅		
R ₁₃₂		Same as R ₁₀₉	Mod. limiter audio filter		
R ₁₃₃	3Z6803-3	Resistor, 3 megohm, 20%, 1/2 watt, carbon, type A1/2	Diode load of tube V ₁₀₅	13	G 31363
R ₁₃₄	2Z7298-4	Resistor, variable, 500,000 ohm, 20%, special	Mod. limiter control	45	G 34776
R ₁₃₅		Same as R ₁₁₀	Grid resistor for tube V ₁₀₆		
R ₁₃₆	3Z4524	Resistor, 500 ohm, 10%, 1/2 watt, carbon, type MB1/2	Cathode bias for tube V ₁₀₆	45	G 31356
R ₁₃₇		Resistor, variable, 100,000 ohm, 20%, special	Sidetone gain control	45	G 34778
R ₁₃₈		Resistor, 100,000 ohm, 10%, 1/2 watt, carbon, type MB1/2	Grid resistor for tube V ₁₀₆	45	G 31357
R ₁₃₉	3Z4528	Resistor, 5,000 ohm, 10%, 1/2 watt, carbon, type MB1/2	Plate resistor for tube V ₁₀₆	45	G 31355
R ₁₄₀		Same as R ₁₃₉	Plate resistor for tube V ₁₀₆	45	G 31355
R ₁₄₁		Same as R ₁₃₃	Decoupling resistor for sidetone output	45	G 31355
R ₁₄₂		Resistor, 200 ohm, 10%, 1 watt, carbon, type MB1	Carbon mic. shunt	45	G 31002
C ₁₀₁		Capacitor, fixed, 0.01 μf, 20%, 600 V. D-C, moulded paper, type 342	A-C line filter	33	G 32351
C ₁₀₂		Same as C ₁₀₁	Coupling between tube V ₁₀₁ and tube V ₁₀₂		

The word Special indicates part made for, or by the Contractor.

35. Table of Replaceable Parts—(Continued)

Circuit Symbol	Sig. C. Stock No.	Name and Description of Part	Function	Mfr.	Contractor's Drawing No.
d. Speech Amplifier BC-614-E Continued					
C ₁₀₃		Same as C ₁₀₁			
C ₁₀₄		Capacitor, fixed, 10 μ f, -10 +75%, 25 V. D-C, electrolytic, special, one section of four sections	Coupling between tube V ₁₀₃ and tube V ₁₀₃		
C ₁₀₅		Same as C ₁₀₁		26	G 34752
C ₁₀₆		Same as C ₁₀₁			
C ₁₀₇		Same as C ₁₀₄ . One section of four section units	Tube V ₁₀₃ cathode by-pass		
C ₁₀₈		Capacitor, fixed, 8 μ f, -10 +40%, 475 V. D-C, electrolytic, special, one unit of dual unit	Coupling between tube V ₁₀₃ and tube V ₁₀₄		
C ₁₀₉		Same as C ₁₀₈ . One unit of dual unit	Tube V ₁₀₄ cathode by-pass		
C ₁₁₀		Capacitor, fixed, 30 μ f, -10 +75%, 25 V. D-C, electrolytic, special, one section of four section units (see C ₁₀₄)	Input filter capacitor of power supply	26	G 34751
C ₁₁₁		Same as C ₁₀₈ . One unit of dual unit	Output filter capacitor of power supply		
C ₁₁₂		Same as C ₁₀₈ . One unit of dual unit	Carbon mic. voltage filter		
C ₁₁₃		Same as C ₁₀₈ . One unit of dual unit	Decoupling filter capacitor		
C ₁₁₄		Same as C ₁₀₈ . One unit of dual unit	Decoupling filter capacitor		
C ₁₁₅		Same as C ₁₀₈ . One unit of dual unit	Decoupling filter capacitor		
C ₁₁₆	3DA350-5	Capacitor, fixed, 0.35 μ f, 10%, 400 V. D-C, oil-filled, paper, bathtub, special	Plate coupling for tube V ₁₀₅		
C ₁₁₇		Capacitor, fixed, 0.002 μ f, 20%, 600 V. D-C, molded paper, type 340-17	Decoupling filter capacitor		
C ₁₁₈		Same as C ₁₁₇	Decoupling filter capacitor		
C ₁₁₉		Same as C ₁₀₁	Decoupling filter capacitor		
C ₁₂₀		Same as C ₁₁₀ . One section of four section units	Decoupling filter capacitor		
C ₁₂₁		Same as C ₁₀₁	Plate coupling for tube V ₁₀₆	33	G 34726
C ₁₂₂		Same as C ₁₁₇	Audio coupling to tube V ₁₀₂	33	G 32251
C ₁₂₃		Same as C ₁₁₇	Carbon mic. voltage filter		
C ₁₂₄		Same as C ₁₁₆	A-C line filter		
C ₁₂₅		Same as C ₁₀₁	R-F filter in keying circuit		
C ₁₂₆		Same as C ₁₀₁	R-F filter in control circuit		
C ₁₂₇		Capacitor, fixed, 0.005 μ f, 20%, 300 V. D-C, mica	Transient filter in control circuit		
C ₁₂₈		Capacitor, fixed, 0.002 μ f, 20%, 600 V. D-C, molded paper, type 340-17	Meter M ₁₀₁ by-pass	33, 40	G 35276
C ₁₂₉		Capacitor, fixed, 0.005 μ f, 20%, 300 V. D-C, mica, type 1467	R-F filter on A-C line	33	G 32251
C ₁₃₀		Capacitor, fixed, 0.005 μ f, 20%, 300 V. D-C, mica, type 1467	R-F by-pass on fil. of tube V ₁₀₁	33	G 35276
CH ₁₀₁	3C548	Inductor, fixed, 29 henries, 0.025 amp. D-C, iron core, type #1C103	R-F by-pass on Jack J ₁₀₂	33	G 35276
T ₁₀₁	2Z9631.3	Transformer; Primary to match 200 ohm, carbon microphone, 0.025 amp. D-C; Secondary to match class "A" grid; Turns ratio primary to secondary 1:1, special, type 2D131	R-F by-pass on receptacle SO ₁₀₂	20	G 26353
T ₁₀₂	2Z9632.4	Transformer; Primary to match 20,000 ohm, push-pull, 6SN7 plates; Secondary to match 500 ohm line, type 2A99	Carbon mic. trans.	20	G 28154
T ₁₀₃	2Z9613.2	Transformer; Primary 117 V. A-C; Secondary (1) 500 V. C.T. at 25 ma., (2) 6.3 V. C.T. at 2 amps, (3) 5 V. at 2 amps., type 5C160	BC-614 output to 500 ohm line	20	G 26257
T ₁₀₄	2Z9631.3	Transformer; Primary impedance 10,000 ohms; Secondary impedance 80,000 ohms, type GT2A109	Plate and filament power transformer	20	G 26256
J ₁₀₁	2Z5524	Jack, closed circuit, type 2A	Mod. limiter transformer	20	G 28155
J ₁₀₂		Jack, 3 circuit jack, type XG-750, special	Key circuit outlet	48	G 32952
			Carbon mic. input	48	G 32955

RADIO SETS SCR-399-A & SCR-499-A

SO ₀₁	2Z5522	Socket, 3 contact, female, chassis connector, type PC3F	Dynamic mic. input	4	G 25327
SO ₀₂		Socket, octal, type P08M-1	Junction Box JB-70-A connection	4	G 25325
SO ₀₃		Socket, octal, chassis connector, type P08F	Transmitter BC-610-E connection	4	G 27701
LM ₁₀₁	2Z5927	Lamp, 6 V. D-C, 0.25 amp., bayonet, type 44	ON-OFF pilot light	19	G 25952
M ₁₀₁	3F930-10	Meter, milliammeter, 0-300 ma. D-C, type DO-53	Tubes V ₃ and V ₄ plate	32	G 27005
V ₁₀₁		Tube VT-103, duo-diode triode	A-F amplifier	47	G 30067
V ₁₀₂		Tube VT-94, triode	A-F amplifier	38, 47	G 30066
V ₁₀₃		Tube VT-231, duo-triode	A-F amp. and phase inverter	47	G 30068
V ₁₀₄		Same as V ₁₀₃	A-F amplifier	38	G 30069
V ₁₀₅		Tube VT-233, duo-diode triode	Mod. limiter		
V ₁₀₆		Same as V ₁₀₃	Sidestone oscillator		
V ₁₀₇		Tube VT-80, duo-diode	Rectifier	38, 47	G 30065
V ₁₀₈		Same as V ₁₀₂	Sidestone A-F amplifier		

e. Cordage

3E2316	Cord CO-316, 6 conductor, shielded, length 11 feet	Power and control connection between PE-95-(*) and truck	3	G 27166
3E2313	Cord CO-313, 2 conductor, length 100 feet	A-C extension	3	G 27167
3E2314	Cord CO-385, 6 conductor, rubber covered, length 14 feet	Power and control connection between JB-70-A and outlet of truck	3	G 28752
3E1659	Cord CO-314, 2 conductor, length 3 feet	A-C connection	3	G 27175
3E1659	Cord CD-659, 2 conductor, rubber covered, 6 feet	Auxiliary battery connection	3	G 27183
3E4142-7	Cord CD-318A, supplied by Government per SC-D-1877-J	Connection for Microphone T-30-()	23	G 34306
3E4142-9	Cord CD-564, 2 conductor, rubber covered, length 3 feet	A-C power connection of BC-342	3	G 27179
3E1763	Cord CD-566, 3 conductor, length 47 inches	Receiver BC-342 control connection	3	G 27174
3E1764	Cord CD-605, supplied by Government per SC-A-7999	Connection for Headset HS-30-()	23	G 34393
	Cord CD-763, 2 conductor, rubber covered, length 14 feet	Transmitter, A-C power cord	3	G 27181
	Cord CD-764, 7 conductor, rubber covered, shielded, length 15 feet	Transmitter control connection	3	G 28751
	Cord CD-690, 2 conductor, rubber covered, length 6 feet	D-C power connection from spare battery to BC-312	3	G 28753
3E4142-8	Cord CD-565, 4 conductor, rubber covered, length 4 feet	Receiver BC-312 control and power connection	3	G 27151
3E1652	Cord CD-652, 6 conductor, shielded, length 100 feet	Power and control extension cable	3	G 27178

f. Junction Box JB-70-A

R ₂₀₀	3Z6010-18	Resistor, 100 ohm, 10%, 1/2 watt, wire wound	Surge filter	41	G 32102
R ₂₀₁		Same as R ₂₀₀	Surge filter		
R ₂₀₂		Same as R ₂₀₀	Surge filter		
R ₂₀₃	3Z4258	Resistor, 5,000 ohm, 10%, 1/2 watt, carbon	Audio attenuation	45	G 31355
R ₂₀₄		Same as R ₂₀₀	Surge filter		
R ₂₀₅		Same as R ₂₀₃	Audio attenuation		
C ₂₀₆	3DA10-128	Capacitor, 0.01 μf, -10 +20%, 600 V. D-C, paper	Surge filter	33	G 32352
C ₂₀₁		Capacitor, 0.01 μf, -10 +20%, 600 V.D-C, paper	Surge filter	38	G 32352
C ₂₀₂	3DB1.7483	Capacitor, 1μf, 10%, 200 V. D-C, bathtub, special	EE-8 isolation	26	G 26055

The word Special indicates part made for, or by the Contractor.

SIGNAL CORPS

35. Table of Replaceable Parts—(Continued)

Circuit Symbol	Sig. C. Stock No.	Name and Description of Part	Function	Mfr.	Contractor's Drawing No.
C ₂₀₃		Same as C ₂₀₁	Surge filter		
C ₂₀₄		Same as C ₂₀₁	Surge filter		
TS ₂₀₀		Terminal strip, 12 terminals, molded bakelite, type 12-140	Termination for BC-614 and main audio cord assy.	28	G 34553
SW ₂₀₀	3Z9845-15	Switch, DPDT, toggle, 3 amp., 250 V. D-C, type 8363	Automatic disabling ON-OFF*	14	G 26418
SW ₂₀₁		Same as SW ₂₀₀	Automatic disabling ON-OFF		
SW ₂₀₂		Switch, 2 section, 5 position, wafer, type H, special	Remote operation selector switch	35	G 26414
SW ₂₀₃		Switch, lever key, 2 way, type A-7697	Trans. control switch	11	G 26417
SW ₂₀₄		Same as SW ₂₀₀	Transpose-normal selector		
SW ₂₀₅		Switch, 1 section, 3 position, wafer, type H, special	CW-SIDETONE selector	35	G 26415
SW ₂₀₆		Switch, start-stop	START-STOP switch	44	G 28252
SW ₂₀₇		Switch, SPDT, toggle, type 8816	PE-95 auxiliary battery switch	14	G 26422
SO ₂₀₀		Socket, 6 prong, male	PE-95 connection	5	G 33451
SO ₂₀₁		Socket, 2 contact, female, twist lock, type 7210	Power receptacle to Radio Transmitter BC-610-E	25	G 25323
SO ₂₀₂		Same as SO ₂₀₁	Power receptacle to heater		
SO ₂₀₃		Socket, 4 contact, flush porcelain receptacle, type 7410	Power receptacle to Rectifier RA-63	25	G 27702
SO ₂₀₄		Socket, 4 contact, receptacle and mounting bracket, special	Power connection to Receiver BC-312-(*)	4	G 27509
SO ₂₀₅		Socket, female, 10 amp., 250 V., type #92-C	Power receptacle to Receiver BC-342-(*)	4	G 25320
SO ₂₀₆		Socket, 3 contact, twistlock, duplex receptacle, type #7580	Power receptacle to aux. battery Chest CH-109-A	25	G 25321
SO ₂₀₇		Socket, twistlock, duplex receptacle, type 9200	Connection to blower	25	G 25216
SO ₂₀₈		Same as SO ₂₀₇	Power receptacle for ceiling lamp and lamp in aux. Chest CH-121		
SO ₂₀₉		Socket, 2 contact, twistlock, duplex, receptacle, 10 amp., 250 V-15 amp., 125 V., type #7540	Receptacle for lamp in main Chest CH-120-A and A-C power line receptacle for Receiver BC-342-(*)	25	G 25322
SO ₂₁₀		Socket, 4 contact, female, type #S-304-AB	Receptacle for aux. audio cord	28	G 25336
CB ₂₀₀		Circuit breaker, 50 amp., molded phenolic compound, type thermostat PLM-50	A-C power overload protection	42	G 28253
RY ₂₀₀	2Z7650.5	Relay, 12 V. D-C, inductance, 1.5 henries, 20%, @ 1,000 C.P.S., type A-11731	"CW" operation and receiver disabling	11	G 27802
J ₂₀₀	2Z5524	Jack, single circuit, type #2A	"CW" connection	48	G 32952
J ₂₀₁		Same as J ₂₀₀	"CW" connection		
J ₂₀₂		Same as J ₂₀₀	Headsets connection for BC-312		
J ₂₀₃		Same as J ₂₀₀	Headsets connection for BC-312		
J ₂₀₄		Same as J ₂₀₀	Headsets connection for BC-342		
J ₂₀₅		Same as J ₂₀₀	Headsets connection for BC-342		

The word Special indicates part made for, or by the Contractor

36. List of Manufacturers.

1. Advance Electric Company
Los Angeles, California
2. Aerovox Corporation
New Bedford, Massachusetts
3. Allen Electric & Equipment Company
2101-17 North Pitcher Street
Kalamazoo, Michigan
4. American Phenolic Corporation
Chicago, Illinois
5. Appleton Electric Company
1701 Wellington Avenue
Chicago, Illinois
6. Associated Research, Inc.
431 South Dearborn Street
Chicago, Illinois
7. Automatic Winding Corporation
900 Passaic Avenue
East Newark, New Jersey
8. Barker-Williamson Company
Upper Darby, Pennsylvania
9. Centralab
900 East Keefe Avenue
Milwaukee, Wisconsin
10. Cinch Manufacturing Corporation
2335 West Van Buren Street
Chicago, Illinois
11. C. P. Clare & Company
4719 West Sunnyside Avenue
Chicago, Illinois
12. Clarostat Manufacturing Company
285-7 North Sixth Street
Brooklyn, New York
13. Continental Carbon, Inc.
13900 Lorain Avenue
Cleveland, Ohio
14. Cutler-Hammer, Inc.
1369 West St. Paul Avenue
Milwaukee, Wisconsin
15. Eagle Electric Manufacturing Company
23-10 Bridge Plaza, South
Long Island City, New York
16. Effengee Supply Company, Inc.
Chicago, Illinois.
17. Eitel-McCullough, Inc.
San Bruno, California
18. Erie Resistor
Erie, Pennsylvania
19. General Electric Company
Schenectady, New York
20. General Transformer Corporation
Chicago, Illinois
21. Guardian Electric Manufacturing Company
Chicago, Illinois
22. E. I. Guthman & Company, Inc.
400 South Peoria Street
Chicago, Illinois
23. **Government furnished**
24. Hart & Hegeman Electric Company
Hartford, Connecticut
25. Harvey Hubbell, Inc.
Bridgeport, Connecticut
26. Industrial Condenser Corporation
1725 West North Avenue
Chicago, Illinois
27. E. F. Johnson Company
Waseca, Minnesota
28. Howard B. Jones
2300 Wabansia Avenue
Chicago, Illinois
29. Leach Relay Company
5915 Avalon Boulevard
Los Angeles, California
30. Lectrohlm, Inc.
5133 West 25th Place
Cicero, Illinois
31. Littelfuse, Inc.
Chicago, Illinois
32. O. B. McClintock Company
Minneapolis, Minnesota
33. Micamold Radio Corporation
Brooklyn, New York
34. National Union Radio Corporation
57 State Street
Newark, New Jersey
35. Oak Manufacturing Company
1260 Clybourn Avenue
Chicago, Illinois
36. Ohmite Manufacturing Company
4835 Flournoy Street
Chicago, Illinois
37. Pass & Seymour, Inc.
Solvay Station
Syracuse, New York
38. RCA Manufacturing Company
Camden, New Jersey
39. S. W. Inductor Company
1056-58 North Wood Street
Chicago, Illinois
40. Solar Manufacturing Company
Bayonne, New Jersey
41. Speer Carbon Company
Lincoln Avenue
St. Marys, Pennsylvania
42. Spencer Thermostat Company
Attleboro, Massachusetts
43. Sprague Specialties Company
North Adams, Massachusetts
44. Square D Company
Detroit, Michigan
45. Stackpole Carbon Company
St. Marys, Pennsylvania
46. Standard Transformer Corporation
1500 North Halsted Street
Chicago, Illinois
47. Sylvania Electric Products, Inc.
Emporium, Pennsylvania
48. Utah Radio Products Company
848 Orleans Street
Chicago, Illinois

SIGNAL CORPS

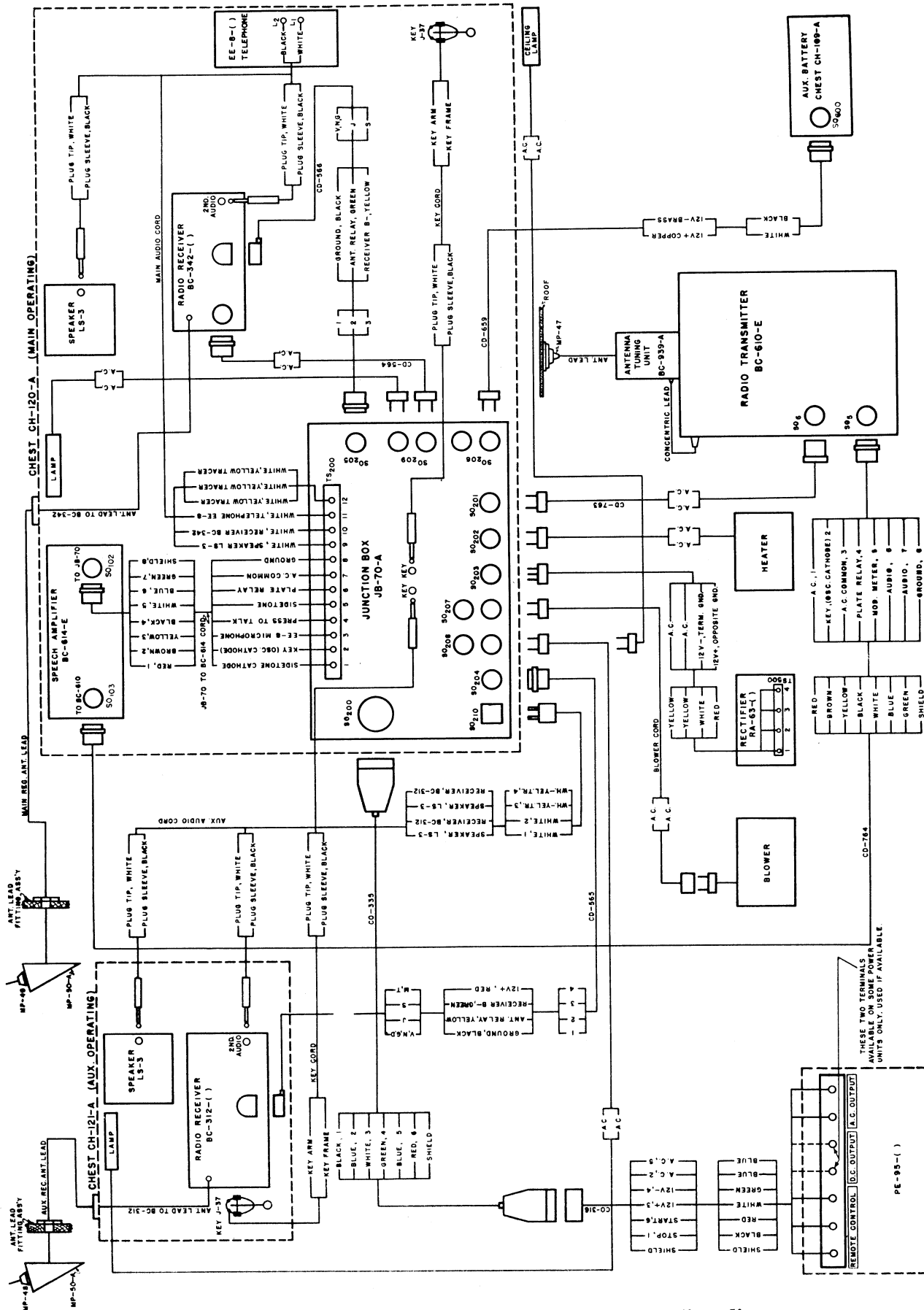

Figure 16—Radio Sets SCR-399-(*) and SCR-499-(*), cording diagram

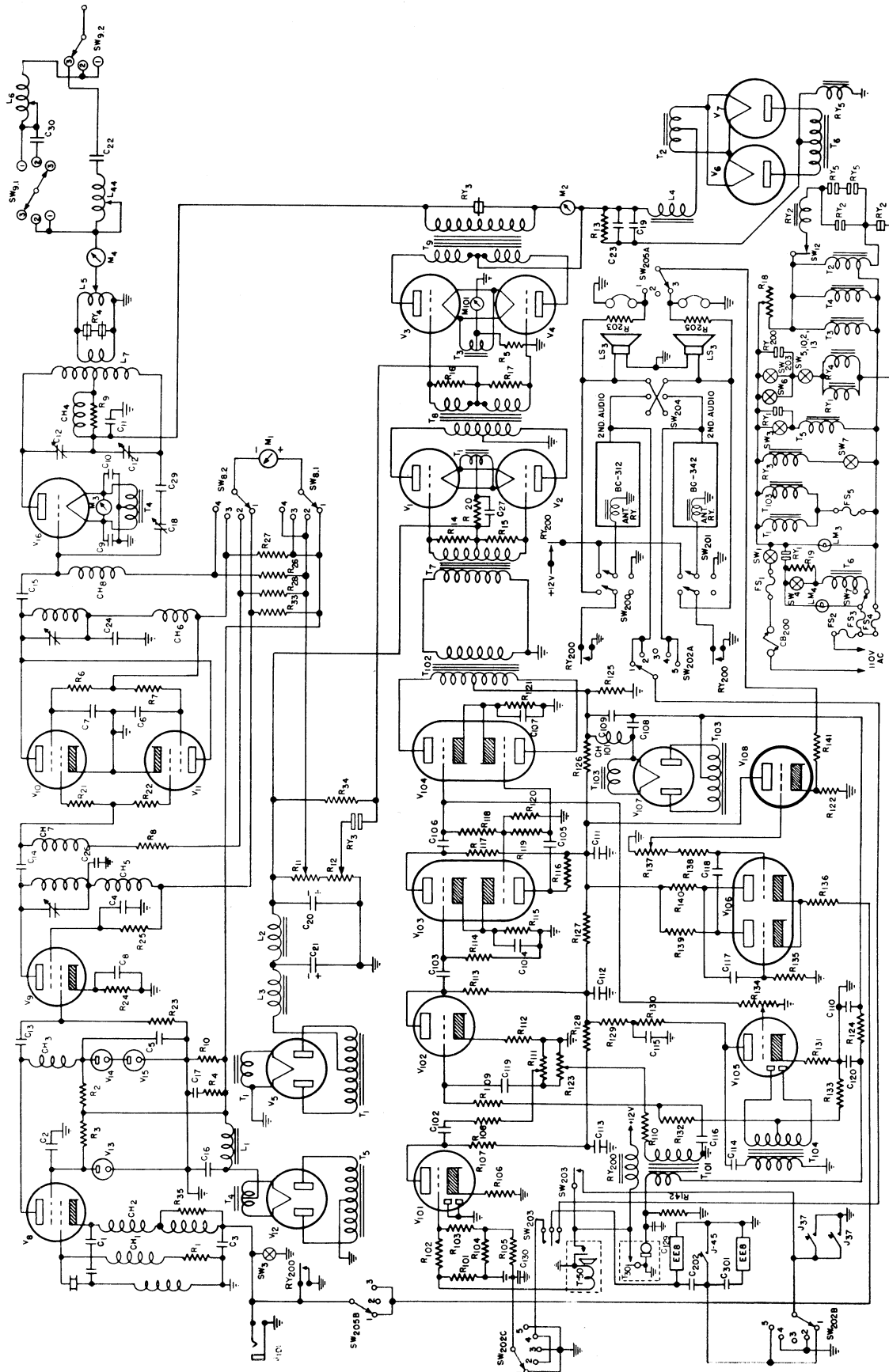

Figure 17—Radio Sets SCR-399-(*) and SCR-499-(*), over-all schematic circuit diagram, simplified

SIGNAL CORPS

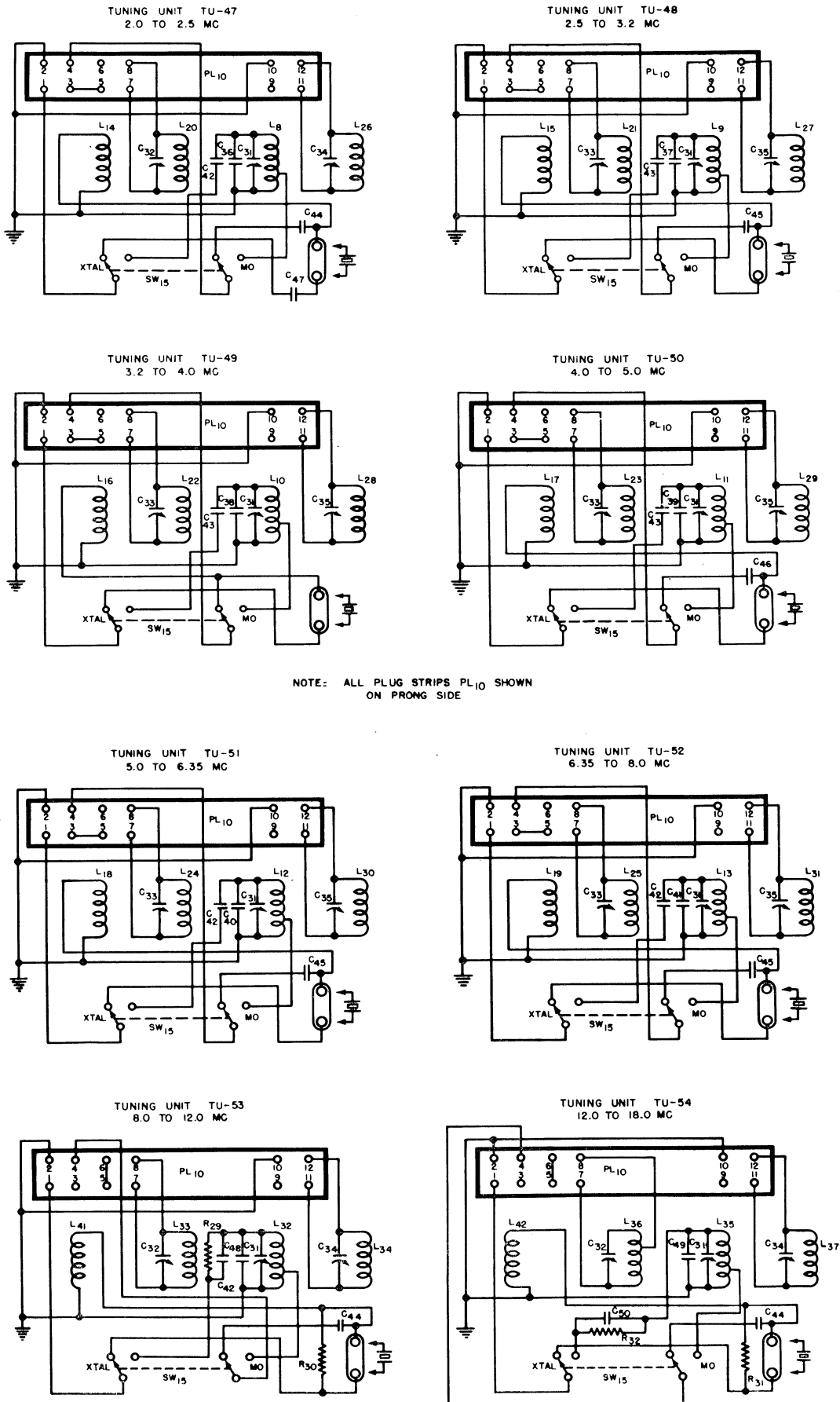

Figure 18—Tuning Units for Radio Transmitter BC-610-E, schematic wiring diagram

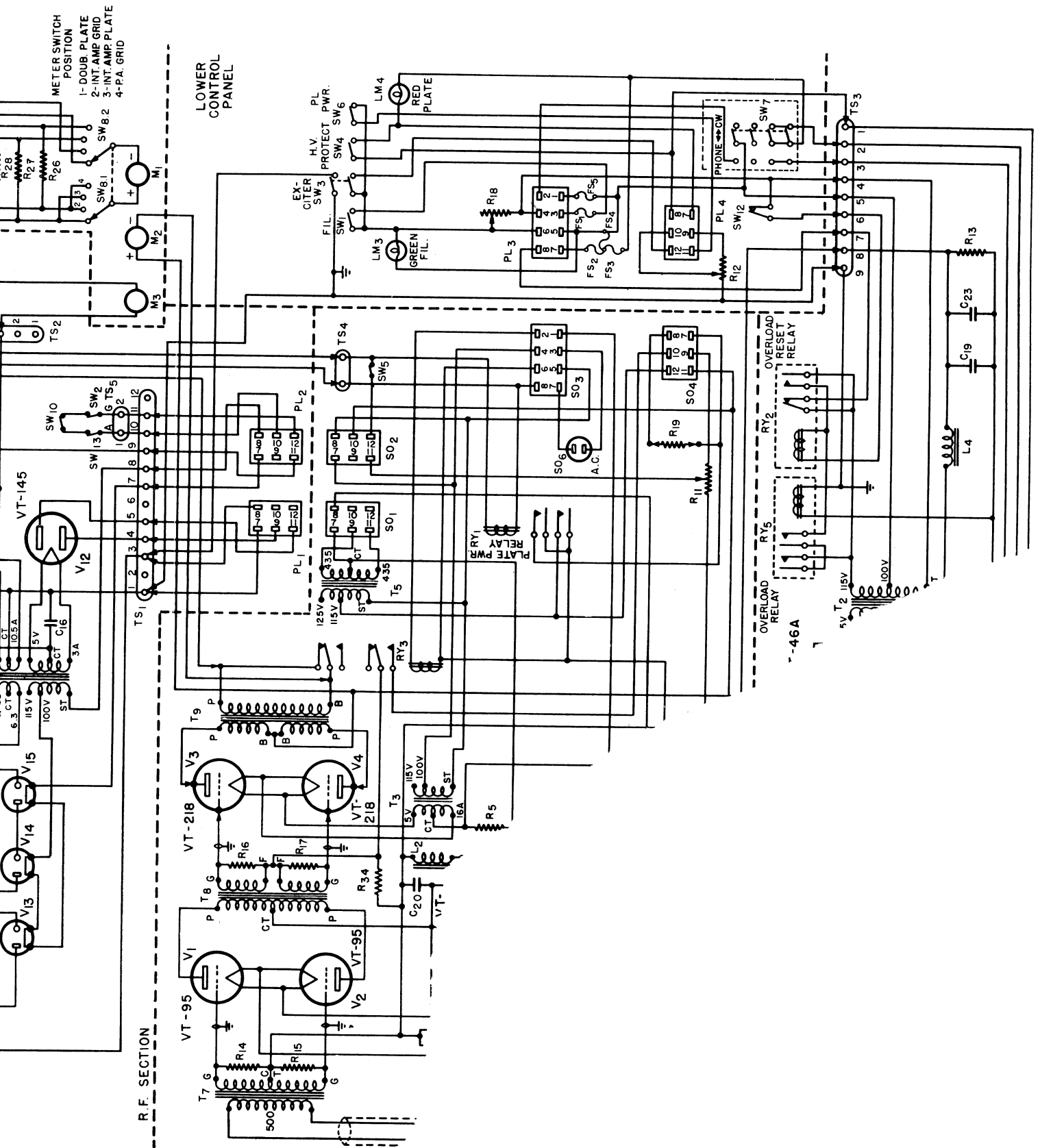

Figure 19—Radio Transm

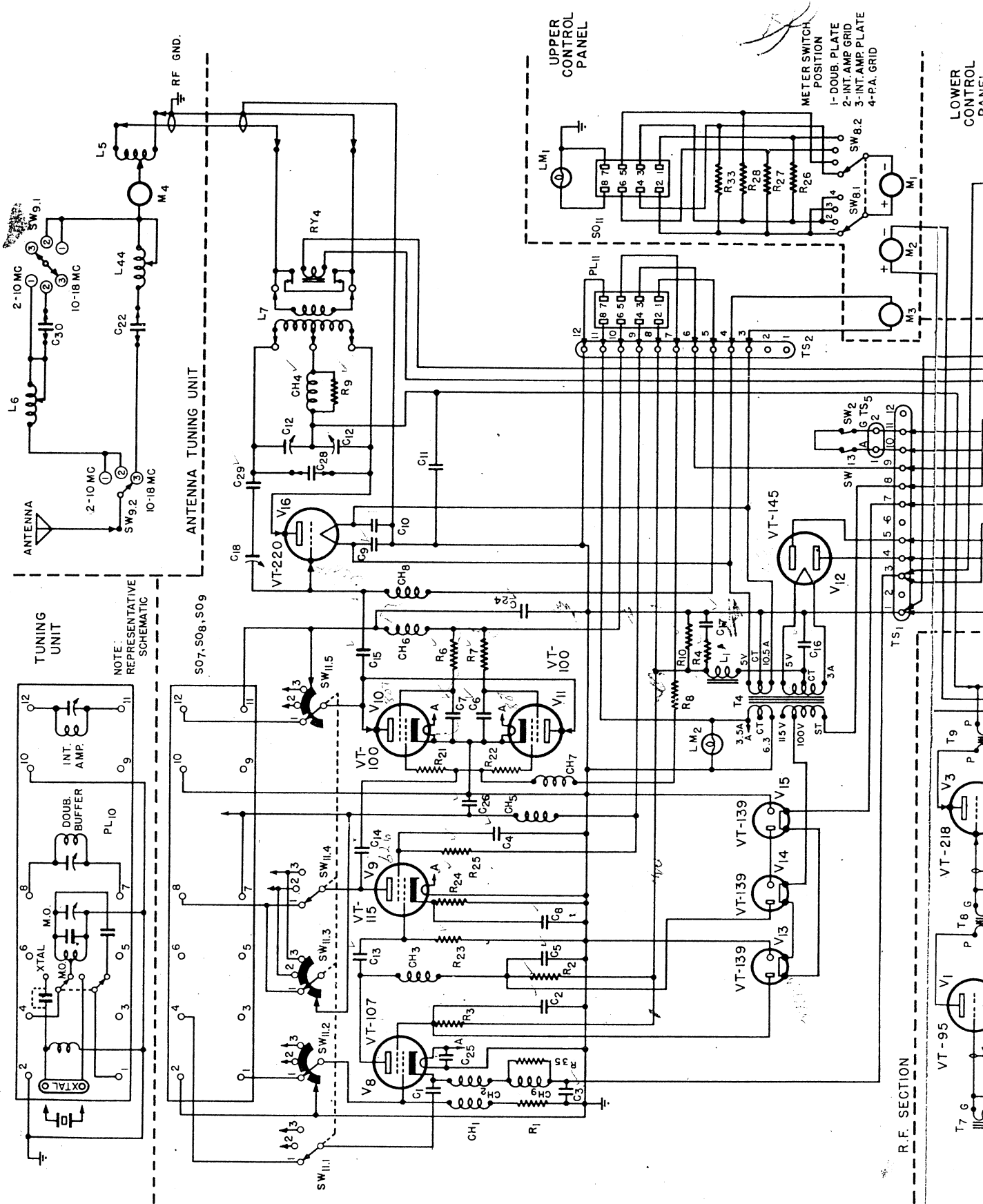
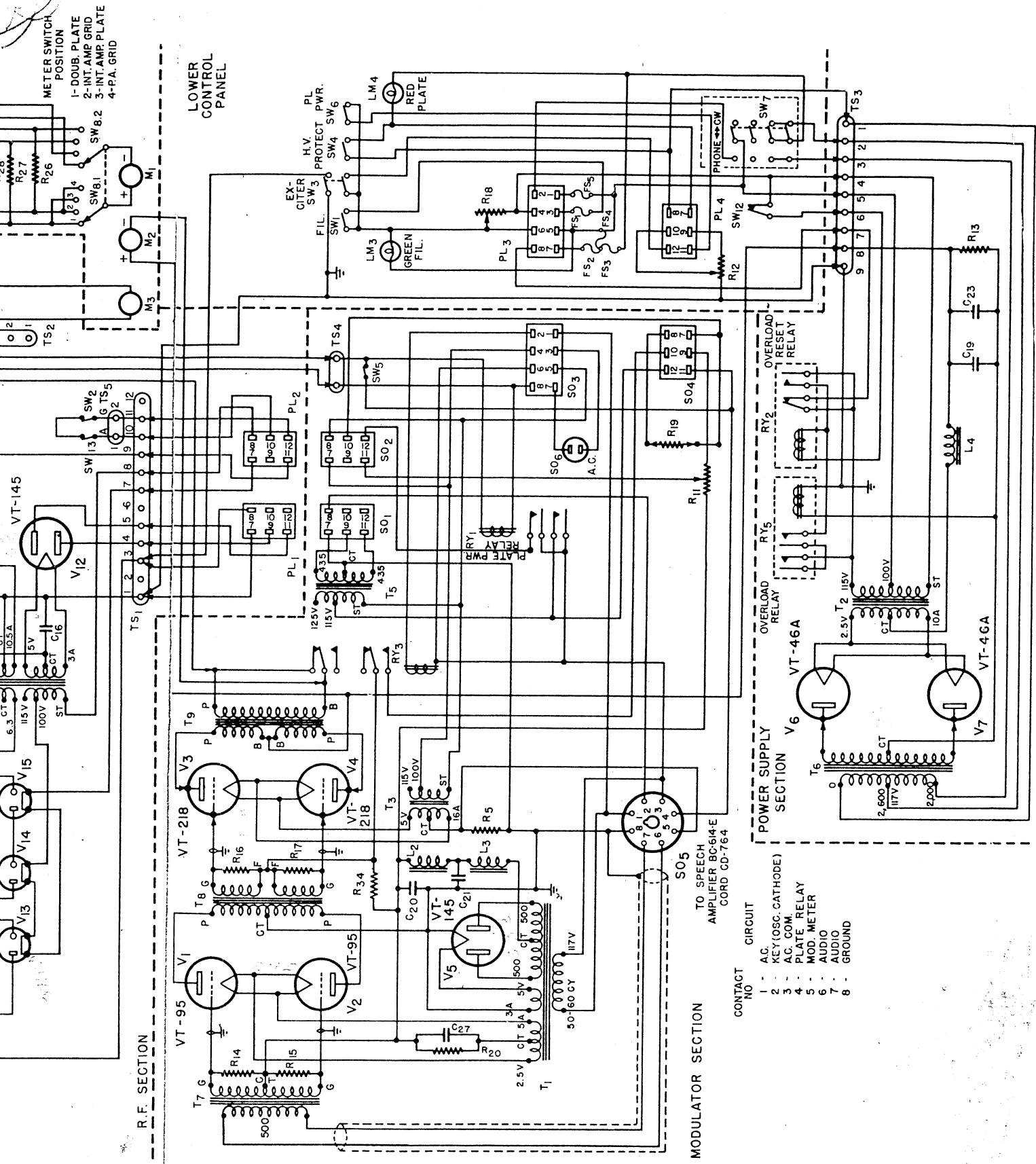

Figure 18 - Radio Transmitter BC-610-E and Antenna Unit BC-939-A, schematic wiring diagram.



R.F. SECTION

MODULATOR SECTION

LOWER CONTROL PANEL

POWER SUPPLY SECTION

- TO SPEECH AMPLIFIER BC-614-E CORD CD-764
- CONTACT NO. CIRCUIT
- 1 - A.C.
 - 2 - KEY (OSC. CATHODE)
 - 3 - A.C. COM.
 - 4 - PLATE RELAY
 - 5 - MOD. METER
 - 6 - AUDIO
 - 7 - AUDIO
 - 8 - GROUND

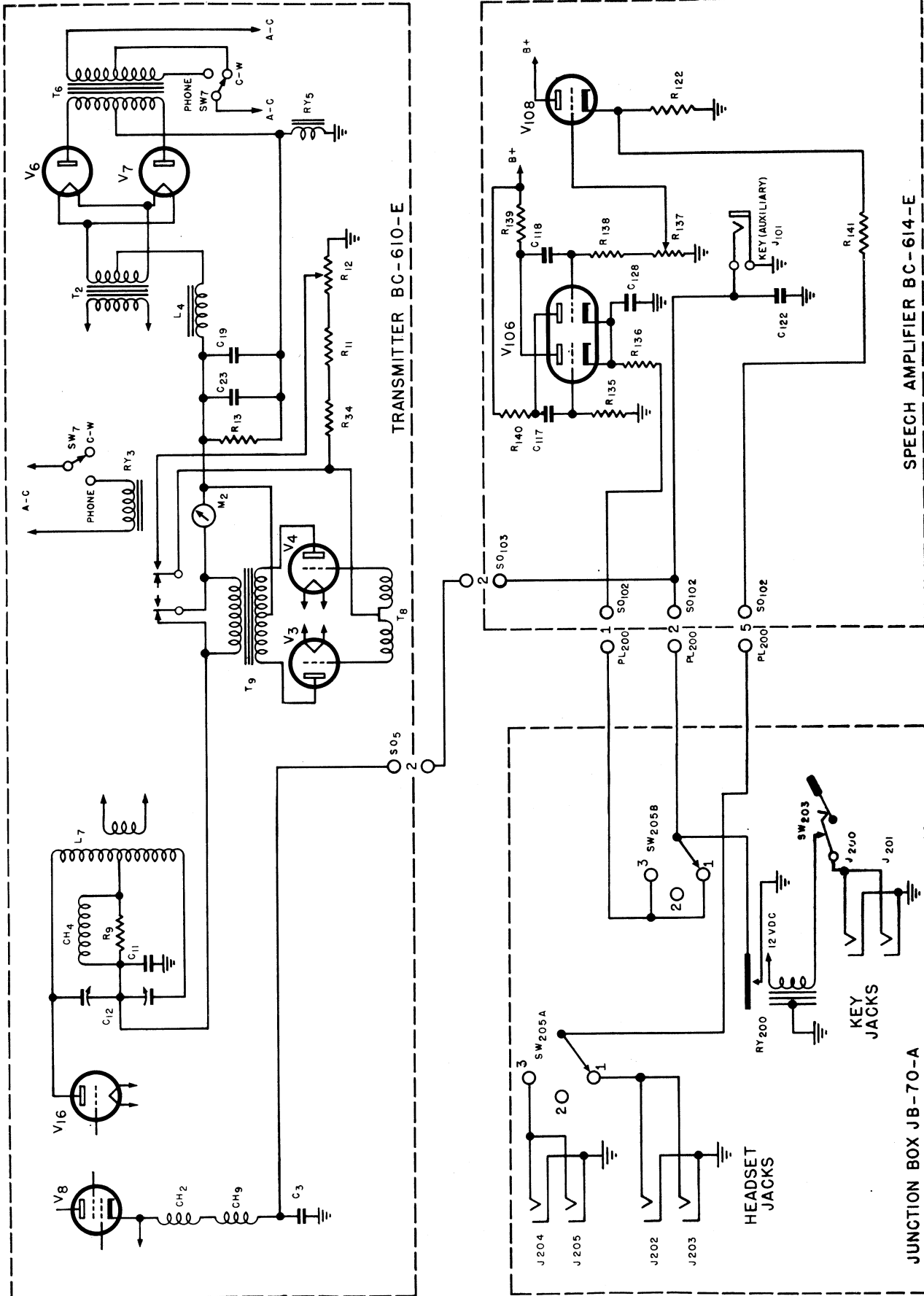

Figure 24—Functional diagram of c-w operation

RADIO SETS SCR-399-A & SCR-499-A

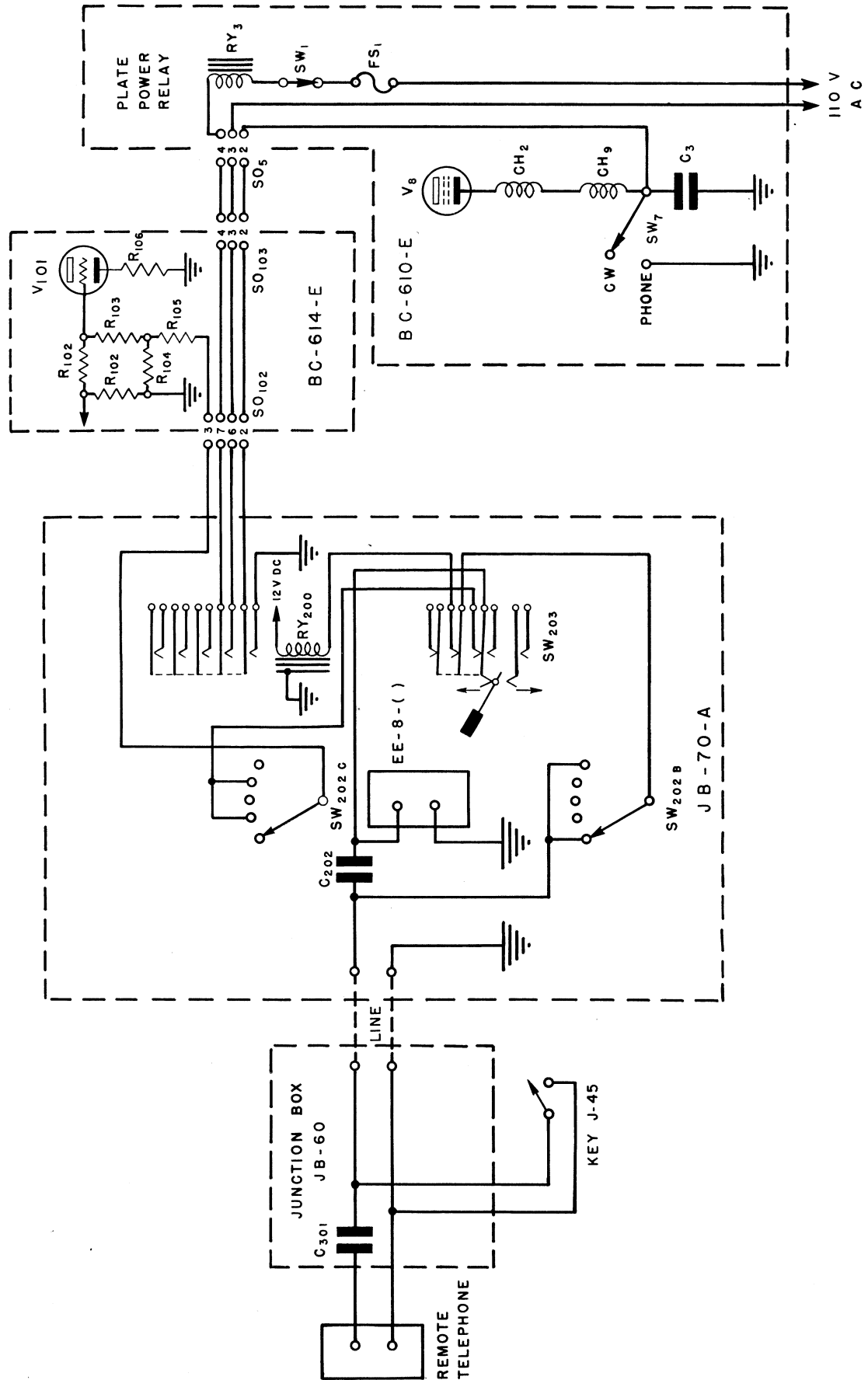

Figure 25—Functional diagram of remote operation

TUNING CHART OF RADIO TRANSMITTER BC-610-E

for

Tuning Unit TU-47

NOTE: Use V. C. 50
On 2-2.5 MC

Frequency Range 2.0-2.5 MC

APPROXIMATE DIAL SETTINGS

OPERATING FREQUENCY IN KILOCYCLES	CRYSTAL FREQUENCY IF USED	COIL UNIT	TUNING CONTROLS			P. A. PLATE TUNING	ANTENNA TUNING UNIT BC-939-A		
			M.O.	DOUB.	INT. AMP.		BAND SWITCH POSITION	COUPLING	LOADING
2000	2000	C-387-B	11	2.4	4.7	13	2-10	2.8	9.2
2050	2050	C-387-B	22	3.2	5.2	24	2-10	2.8	11.5
2100	2100	C-387-B	32	3.8	5.5	33	2-10	2.8	13.5
2150	2150	C-387-B	41	4.3	5.9	41	2-10	2.8	15.6
2200	2200	C-387-B	49	4.8	6.3	48	2-10	2.8	17.4
2250	2250	C-387-B	57	5.2	6.7	55	2-10	2.8	19.0
2300	2300	C-387-B	63	5.6	7.0	61	2-10	2.8	20.4
2350	2350	C-387-B	69	6.0	7.4	67	2-10	2.8	21.8
2400	2400	C-387-B	75	6.3	7.7	72	2-10	2.8	23.1
2450	2450	C-387-B	81	6.7	8.0	79	2-10	2.8	24.4
2500	2500	C-387-B	85	7.0	8.2	84	2-10	2.8	25.5

NOTE — FOR EXACT M.O. SETTING, USE FREQUENCY METER SET SCR-211-(*)

PART No. G 28804

Figure 27—Tuning Chart of Tuning Unit TU-47

TUNING CHART OF RADIO TRANSMITTER BC-610-E

for

Tuning Unit TU-48

Frequency Range 2.5-3.2 MC

APPROXIMATE DIAL SETTINGS

OPERATING FREQUENCY IN KILOCYCLES	CRYSTAL FREQUENCY IF USED	COIL UNIT	TUNING CONTROLS			P. A. PLATE TUNING	ANTENNA TUNING UNIT BC-939-A		
			M.O.	DOUB.	INT. AMP.		BAND SWITCH POSITION	COUPLING	LOADING
2500	2500	C-387-B	10	0.7	2.8	6	2-10	2.4	25.7
2550	2550	C-387-B	18	1.7	3.4	11	2-10	2.4	27.0
2600	2600	C-387-B	26	2.4	3.9	15	2-10	2.4	28.0
2650	2650	C-387-B	33	3.1	4.4	20	2-10	2.4	29.0
2700	2700	C-387-B	40	3.7	4.9	24	2-10	2.4	30.0
2750	2750	C-387-B	46	4.1	5.3	27	2-10	2.4	30.9
2800	2800	C-387-B	52	4.5	5.8	31	2-10	2.5	31.8
2850	2850	C-387-B	58	4.9	6.1	35	2-10	2.5	32.6
2900	2900	C-387-B	63	5.2	6.5	38	2-10	2.5	33.4
2950	2950	C-387-B	68	5.6	6.8	41	2-10	2.5	34.1
3000	3000	C-387-B	73	5.9	7.2	44	2-10	2.5	34.8
3050	3050	C-387-B	78	6.1	7.4	47	2-10	2.5	35.5
3100	3100	C-387-B	82	6.4	7.7	50	2-10	2.5	36.1
3150	3150	C-387-B	87	6.6	7.9	53	2-10	2.5	36.8
3200	3200	C-387-B	90	6.8	8.0	56	2-10	2.5	37.4

NOTE — FOR EXACT M.O. SETTING, USE FREQUENCY METER SET SCR-211-(*).

PART No. G 28804

Figure 28—Tuning Chart of Tuning Unit TU-48

TUNING CHART OF RADIO TRANSMITTER BC-610-E

for

Tuning Unit TU-49

Frequency Range 3.2-4.0 MC

APPROXIMATE DIAL SETTINGS

OPERATING FREQUENCY IN KILOCYCLES	CRYSTAL FREQUENCY IF USED	COIL UNIT	TUNING CONTROLS			P. A. PLATE TUNING	ANTENNA TUNING UNIT BC-939-A		
			M.O.	DOUB.	INT. AMP.		BAND SWITCH POSITION	COUPLING	LOADING
3200	3200	C-387-B	25	3.4	5.8	56	2-10	2.7	37.4
3250	3250	C-387-B	30	3.8	6.1	59	2-10	2.7	37.8
3300	3300	C-387-B	35	4.2	6.3	61	2-10	2.6	38.3
3350	3350	C-387-B	40	4.6	6.5	63	2-10	2.6	38.8
3400	3400	C-387-B	45	4.9	6.7	65	2-10	2.5	39.3
3450	3450	C-387-B	50	5.3	6.9	67	2-10	2.4	39.8
3500	3500	C-387-B	55	5.6	7.1	69	2-10	2.4	40.3
3550	3550	C-388-A	59	5.9	7.3	18	2-10	1.7	40.7
3600	3600	C-388-A	64	6.1	7.5	21	2-10	1.7	41.1
3650	3650	C-388-A	68	6.4	7.7	24	2-10	1.7	41.5
3700	3700	C-388-A	72	6.6	7.9	27	2-10	1.7	41.9
3750	3750	C-388-A	75	6.8	8.1	30	2-10	1.7	42.3
3800	3800	C-388-A	79	7.0	8.3	32	2-10	1.7	42.7
3850	3850	C-388-A	82	7.2	8.5	35	2-10	1.7	43.1
3900	3900	C-388-A	85	7.4	8.7	37	2-10	1.7	43.4
3950	3950	C-388-A	88	7.6	8.8	40	2-10	1.7	43.8
4000	4000	C-388-A	91	7.8	8.9	42	2-10	1.7	44.2

NOTE — FOR EXACT M.O. SETTING, USE FREQUENCY METER SET SCR-211-(*).

PART No. G 28805

Figure 29—Tuning Chart of Tuning Unit TU-49

TUNING CHART OF RADIO TRANSMITTER BC-610-E

for

Tuning Unit TU-50

Frequency Range 4.0-5.0 M C

APPROXIMATE DIAL SETTINGS

OPERATING FREQUENCY IN KILOCYCLES	CRYSTAL FREQUENCY IF USED	COIL UNIT	TUNING CONTROLS			P. A. PLATE TUNING	ANTENNA TUNING UNIT BC-939-A		
			M.O.	DOUB.	INT. AMP.		BAND SWITCH POSITION	COUPLING	LOADING
4000	2000	C-388-A	7	2.2	3.5	42	2-10	1.8	44.2
4050	2025	C-388-A	13	2.5	3.9	45	2-10	1.8	44.5
4100	2050	C-388-A	19	2.9	4.3	47	2-10	1.8	44.8
4150	2075	C-388-A	24	3.2	4.6	49	2-10	1.8	45.2
4200	2100	C-388-A	29	3.5	5.0	51	2-10	1.8	45.4
4250	2125	C-388-A	34	3.8	5.3	53	2-10	1.8	45.7
4300	2150	C-388-A	39	4.1	5.6	55	2-10	1.8	46.0
4350	2175	C-388-A	44	4.4	5.9	57	2-10	1.8	46.3
4400	2200	C-388-A	48	4.6	6.1	59	2-10	1.8	46.5
4450	2225	C-388-A	52	4.8	6.4	60	2-10	1.8	46.7
4500	2250	C-388-A	56	5.1	6.6	62	2-10	1.8	47.0
4550	2275	C-389-A	60	5.3	6.8	18	2-10	1.8	47.3
4600	2300	C-389-A	64	5.6	7.0	20	2-10	1.8	47.5
4650	2325	C-389-A	67	5.8	7.2	23	2-10	1.8	47.7
4700	2350	C-389-A	71	6.0	7.3	25	2-10	1.8	47.9
4750	2375	C-389-A	74	6.2	7.5	28	2-10	1.8	48.2
4800	2400	C-389-A	78	6.4	7.7	30	2-10	1.8	48.3
4850	2425	C-389-A	81	6.6	7.8	32	2-10	1.8	48.5
4900	2450	C-389-A	84	6.8	8.0	34	2-10	1.8	48.7
4950	2475	C-389-A	88	7.0	8.2	36	2-10	1.8	48.9
5000	2500	C-389-A	91	7.1	8.4	38	2-10	1.8	49.1

NOTE — FOR EXACT M.O. SETTING, USE FREQUENCY METER SET SCR-211-(*)

PART No. G 28805

Figure 30—Tuning Chart of Tuning Unit TU-50

TUNING CHART OF RADIO TRANSMITTER BC-610-E

for

Tuning Unit TU-51

Frequency Range 5-6.35

APPROXIMATE DIAL SETTINGS

OPERATING FREQUENCY IN KILOCYCLES	CRYSTAL FREQUENCY IF USED	COIL UNIT	TUNING CONTROLS			P. A. PLATE TUNING	ANTENNA TUNING UNIT BC-939-A		
			M. O.	DOUB.	INT. AMP.		BAND SWITCH POSITION	COUPLING	LOADING
5000	2500	C-389-A	5	2.5	4.0	38	2-10	1.8	49.1
5050	2525	C-389-A	10	2.8	4.3	40	2-10	1.8	49.3
5100	2550	C-389-A	15	3.1	4.6	41	2-10	1.8	49.5
5150	2575	C-389-A	19	3.4	4.8	43	2-10	1.9	49.7
5200	2600	C-389-A	23	3.7	5.1	45	2-10	1.9	49.8
5250	2625	C-389-A	27	3.9	5.3	47	2-10	1.9	50.0
5300	2650	C-389-A	31	4.2	5.6	48	2-10	1.9	50.2
5350	2675	C-389-A	34	4.4	5.8	50	2-10	1.9	50.4
5400	2700	C-389-A	38	4.6	6.0	52	2-10	1.9	50.6
5450	2725	C-389-A	41	4.8	6.2	53	2-10	1.9	50.7
5500	2750	C-389-A	44	5.0	6.4	55	2-10	1.9	50.9
5550	2775	C-389-A	48	5.2	6.6	57	2-10	1.9	51.1
5600	2800	C-389-A	51	5.4	6.7	59	2-10	1.9	51.2
5650	2825	C-389-A	55	5.5	6.9	60	2-10	1.9	51.4
5700	2850	C-389-A	58	5.7	7.1	61	2-10	1.9	51.6
5750	2875	C-390-A	61	5.9	7.2	23	2-10	1.9	51.5
5800	2900	C-390-A	64	6.1	7.4	25	2-10	1.9	51.6
5850	2925	C-390-A	66	6.2	7.5	27	2-10	1.8	51.8
5900	2950	C-390-A	69	6.4	7.7	29	2-10	1.8	51.9
5950	2975	C-390-A	72	6.5	7.8	31	2-10	1.7	52.0
6000	3000	C-390-A	74	6.7	8.0	32	2-10	1.6	52.1
6050	3025	C-390-A	77	6.8	8.1	34	2-10	1.6	52.2
6100	3050	C-390-A	79	7.0	8.2	36	2-10	1.6	52.3
6150	3075	C-390-A	82	7.1	8.4	37	2-10	1.6	52.5
6200	3100	C-390-A	84	7.2	8.5	39	2-10	1.6	52.6
6250	3125	C-390-A	87	7.3	8.7	41	2-10	1.6	52.7
6300	3150	C-390-A	89	7.5	8.8	42	2-10	1.6	52.8
6350	3175	C-390-A	90	7.5	8.9	43	2-10	1.6	52.9

NOTE — FOR EXACT M. O. SETTING, USE FREQUENCY METER SET SCR-211-(*).

PART No. G 28806

Figure 31—Tuning Chart of Tuning Unit TU-51

TUNING CHART OF RADIO TRANSMITTER BC-610-E

for

Tuning Unit TU-52

Frequency Range 6.35-8.0 MC

APPROXIMATE DIAL SETTINGS

OPERATING FREQUENCY IN KILOCYCLES	CRYSTAL FREQUENCY IF USED	COIL UNIT	TUNING CONTROLS			P. A. PLATE TUNING	ANTENNA TUNING UNIT BC-939-A		
			M.O.	DOUB.	INT. AMP.		BAND SWITCH POSITION	COUPLING	LOADING
6350	3175	C-390-A	8	4.4	2.8	43	2-10	1.5	52.9
6400	3200	C-390-A	10	4.6	3.3	45	2-10	1.5	53.0
6500	3250	C-390-A	17	5.0	3.8	48	2-10	1.5	53.2
6600	3300	C-390-A	23	5.4	4.2	50	2-10	1.4	53.4
6700	3350	C-390-A	29	5.8	4.7	53	2-10	1.4	53.6
6800	3400	C-390-A	35	6.1	5.1	55	2-10	1.3	53.8
6900	3450	C-390-A	41	6.4	5.6	57	2-10	1.3	54.0
7000	3500	C-390-A	47	6.6	6.0	60	2-10	1.3	54.2
7100	3550	C-390-A	52	6.9	6.4	62	2-10	1.2	54.4
7200	3600	C-390-A	57	7.1	6.8	64	2-10	1.2	54.5
7300	3650	C-390-A	62	7.3	7.1	66	2-10	1.2	54.7
7400	3700	C-390-A	67	7.5	7.4	68	2-10	1.1	54.9
7500	3750	C-390-A	71	7.7	7.7	70	2-10	1.1	55.1
7600	3800	C-390-A	75	7.9	8.0	72	2-10	1.1	55.2
7700	3850	C-390-A	79	8.1	8.2	73	2-10	1.1	55.4
7800	3900	C-390-A	83	8.3	8.4	74	2-10	1.0	55.5
7900	3950	C-390-A	87	8.4	8.6	76	2-10	1.0	55.7
8000	4000	C-390-A	91	8.5	8.8	77	2-10	1.0	55.8

NOTE — FOR EXACT M.O. SETTING, USE FREQUENCY METER SET SCR-211-(*)

PART No. G 28806

Figure 32—Tuning Chart of Tuning Unit TU-52

TUNING CHART OF RADIO TRANSMITTER BC-610-E

for

Tuning Unit TU-53

Frequency Range 8.0-12.0 M C

APPROXIMATE DIAL SETTINGS

OPERATING FREQUENCY IN KILOCYCLES	CRYSTAL FREQUENCY IF USED	COIL UNIT	TUNING CONTROLS			P. A. PLATE TUNING	ANTENNA TUNING UNIT BC-939-A		
			M.O.	DOUB.	INT. AMP.		BAND SWITCH POSITION	COUPLING	LOADING
8000	4000	C-447	6	1.5	1.5	22	2-10	1.0	55.7
8100	4050	C-447	9	1.8	1.8	25	2-10	0.9	55.8
8200	4100	C-447	13	2.0	2.0	27	2-10	0.9	56.0
8300	4150	C-447	16	2.3	2.3	30	2-10	0.8	56.2
8400	4200	C-447	19	2.6	2.6	32	2-10	0.8	56.3
8500	4250	C-447	23	2.8	2.8	34	2-10	0.8	56.4
8600	4300	C-447	26	3.1	3.1	36	2-10	0.8	56.6
8700	4350	C-447	29	3.3	3.3	38	2-10	0.8	56.8
8800	4400	C-447	32	3.6	3.6	41	2-10	0.8	56.9
8900	4450	C-447	35	3.8	3.8	43	2-10	0.9	57.1
9000	4500	C-447	38	4.0	4.0	45	2-10	0.9	57.2
9100	4550	C-447	41	4.2	4.2	47	2-10	1.0	57.3
9200	4600	C-447	43	4.3	4.3	49	2-10	1.0	57.5
9300	4650	C-447	46	4.5	4.5	51	2-10	1.0	57.6
9400	4700	C-447	49	4.7	4.7	53	2-10	1.1	57.7
9500	4750	C-447	51	4.9	4.9	55	2-10	1.1	57.8
9600	4800	C-447	53	5.1	5.1	57	2-10	1.1	58.0
9700	4850	C-447	55	5.3	5.3	58	2-10	1.1	58.1
9800	4900	C-447	57	5.4	5.4	60	2-10	1.1	58.2
9900	4950	C-447	59	5.6	5.6	62	2-10	1.1	58.4
10,000	5000	C-447	61	5.7	5.7	63	2-10	1.1	58.5

NOTE — FOR EXACT M. O. SETTING, USE FREQUENCY METER SET SCR-211-(*).

(OVER)

PART No. G 28807

Figure 33—Tuning Chart of Tuning Unit TU-53

TUNING CHART OF RADIO TRANSMITTER BC-610-E

for

Tuning Unit TU-53

Frequency Range 8.0-12.0 M C

APPROXIMATE DIAL SETTINGS

OPERATING FREQUENCY IN KILOCYCLES	CRYSTAL FREQUENCY IF USED	COIL UNIT	TUNING CONTROLS			P. A. PLATE TUNING	ANTENNA TUNING UNIT BC-939-A		
			M.O.	DOUB.	INT. AMP.		BAND SWITCH POSITION	COUPLING	LOADING
10,000	5000	C-447	61	5.7	5.7	63	10-18	1.1	*2.5
10,100	5050	C-447	63	5.8	5.8	64	10-18	1.1	*2.9
10,200	5100	C-447	65	6.0	6.0	66	10-18	1.1	*3.1
10,300	5150	C-447	67	6.2	6.2	67	10-18	1.1	*3.4
10,400	5200	C-447	68	6.3	6.3	68	10-18	1.1	*3.8
10,500	5250	C-447	70	6.4	6.4	70	10-18	1.1	*4.0
10,600	5300	C-447	72	6.6	6.6	71	10-18	1.1	*4.3
10,700	5350	C-447	73	6.7	6.7	72	10-18	1.1	*4.7
10,800	5400	C-447	75	6.8	6.8	73	10-18	1.1	*5.0
10,900	5450	C-447	76	7.0	7.0	74	10-18	1.1	*5.3
11,000	5500	C-447	78	7.1	7.1	76	10-18	1.1	*5.6
11,100	5550	C-448	79	7.2	7.2	40	10-18	1.5	*5.9
11,200	5600	C-448	81	7.3	7.3	42	10-18	1.5	*6.3
11,300	5650	C-448	82	7.4	7.4	44	10-18	1.5	*6.6
11,400	5700	C-448	83	7.5	7.5	45	10-18	1.5	*6.8
11,500	5750	C-448	84	7.6	7.6	47	10-18	1.5	*7.0
11,600	5800	C-448	85	7.7	7.7	48	10-18	1.5	*7.3
11,700	5850	C-448	86	7.8	7.8	50	10-18	1.5	*7.5
11,800	5900	C-448	87	7.9	7.9	51	10-18	1.5	*7.8
11,900	5950	C-448	88	8.0	8.0	53	10-18	1.5	*8.1
12,000	6000	C-448	90	8.1	8.1	54	10-18	1.5	*8.3

NOTE— FOR EXACT M.O. SETTING, USE FREQUENCY METER SET SCR-211-(*)
 *Set L.F. Loading Coil at 30

PART No. G 28807

Figure 34—Tuning Chart of Tuning Unit TU-53—(Cont'd.)

TUNING CHART OF RADIO TRANSMITTER BC-610-E

for

Tuning Unit TU-54

Frequency Range 12-18 M C

APPROXIMATE DIAL SETTINGS

OPERATING FREQUENCY IN KILOCYCLES	CRYSTAL FREQUENCY IF USED	COIL UNIT	TUNING CONTROLS			P. A. PLATE TUNING	ANTENNA TUNING UNIT BC-939-A		
			M.O.	DOUB.	INT. AMP.		BAND SWITCH POSITION	COUPLING	LOADING
12,000	3000	C-448	6	.3	1.1	54	10-18	1.4	*8.3
12,100	3025	C-448	9	.4	1.4	55	10-18	1.4	*8.6
12,200	3050	C-448	12	.6	1.6	57	10-18	1.4	*8.8
12,300	3075	C-448	14	.8	1.8	58	10-18	1.4	*9.0
12,400	3100	C-448	17	1.0	2.1	59	10-18	1.4	*9.2
12,500	3125	C-448	19	1.2	2.3	61	10-18	1.4	*9.4
12,600	3150	C-448	21	1.4	2.5	62	10-18	1.4	*9.6
12,700	3175	C-448	23	1.5	2.7	63	10-18	1.4	*9.8
12,800	3200	C-448	25	1.7	2.9	64	10-18	1.3	*10.0
12,900	3225	C-448	27	1.8	3.1	65	10-18	1.3	*10.2
13,000	3250	C-448	29	1.9	3.2	66	10-18	1.3	*10.4
13,100	3275	C-448	31	2.1	3.3	67	10-18	1.3	*10.6
13,200	3300	C-448	33	2.2	3.5	68	10-18	1.3	*10.7
13,300	3325	C-448	35	2.4	3.7	69	10-18	1.3	*10.9
13,400	3350	C-448	37	2.5	3.8	70	10-18	1.3	*11.0
13,500	3375	C-448	38	2.6	4.0	71	10-18	1.3	*11.2
13,600	3400	C-448	40	2.7	4.1	72	10-18	1.3	*11.4
13,700	3425	C-448	41	2.8	4.3	72	10-18	1.3	*11.5
13,800	3450	C-448	43	3.0	4.4	73	10-18	1.3	*11.6
13,900	3475	C-448	45	3.1	4.5	74	10-18	1.3	*11.7
14,000	3500	C-448	46	3.2	4.6	75	10-18	1.3	*11.8

NOTE — FOR EXACT M.O. SETTING, USE FREQUENCY METER SET SCR-211-(*)
 *Set L.F. Loading Coil at 30

(OVER)

PART No. G 28808

Figure 35—Tuning Chart of Tuning Unit TU-54

TUNING CHART OF RADIO TRANSMITTER BC-610-E

for

Tuning Unit TU-54

Frequency Range 12-18 MC

APPROXIMATE DIAL SETTINGS

OPERATING FREQUENCY IN KILOCYCLES	CRYSTAL FREQUENCY IF USED	COIL UNIT	TUNING CONTROLS			P. A. PLATE TUNING	ANTENNA TUNING UNIT BC-939-A		
			M.O.	DOUB.	INT. AMP.		BAND SWITCH POSITION	COUPLING	LOADING
14,200	3550	C-449	49	3.4	4.8	34	10-18	0.8	*12.0
14,400	3600	C-449	52	3.6	5.1	37	10-18	0.8	*12.4
14,600	3650	C-449	55	3.8	5.3	40	10-18	0.8	*12.7
14,800	3700	C-449	58	3.9	5.5	42	10-18	0.8	*13.1
15,000	3750	C-449	61	4.1	5.7	45	10-18	0.8	*13.4
15,200	3800	C-449	63	4.3	5.8	47	10-18	0.8	*13.7
15,400	3850	C-449	65	4.5	6.1	49	10-18	0.8	*14.0
15,600	3900	C-449	68	4.7	6.2	52	10-18	0.8	*14.3
15,800	3950	C-449	70	4.8	6.4	54	10-18	0.8	*14.6
16,000	4000	C-449	72	5.0	6.6	56	10-18	0.8	*14.9
16,200	4050	C-449	74	5.2	6.7	58	10-18	0.8	*15.3
16,400	4100	C-449	76	5.3	6.8	60	10-18	0.8	*15.7
16,600	4150	C-449	78	5.5	6.9	62	10-18	0.8	*16.0
16,800	4200	C-449	80	5.6	7.1	64	10-18	0.8	*16.3
17,000	4250	C-449	82	5.7	7.2	66	10-18	0.8	*16.6
17,200	4300	C-449	84	5.8	7.4	68	10-18	0.8	*16.9
17,400	4350	C-449	85	5.9	7.5	69	10-18	0.8	*17.3
17,600	4400	C-449	87	6.1	7.7	71	10-18	0.8	*17.7
17,800	4450	C-449	89	6.2	7.9	72	10-18	0.8	*18.2
18,000	4500	C-449	91	6.3	8.1	74	10-18	0.8	*18.7

NOTE — FOR EXACT M.O. SETTING, USE FREQUENCY METER SET SCR-211-(*)
 *Set L.F. Loading Coil at 30

PART No. G 28808

Figure 36—Tuning Chart of Tuning Unit TU-54—(Cont'd.)



[A. G. 062.11 (4-Sep-43)]

By Order of the Secretary of War:

G. C. MARSHALL,
Chief of Staff.

Official:

J. A. ULIO,
Major General,
The Adjutant General.

Distribution:

1Bn 11 (2), IC 11 (5)



